

**Smart PV Management System  
V300R006C00**

**User Manual**

**Issue**        **02**  
**Date**        **2019-05-30**

**Copyright © Huawei Technologies Co., Ltd. 2019. All rights reserved.**

No part of this document may be reproduced or transmitted in any form or by any means without prior written consent of Huawei Technologies Co., Ltd.

## **Trademarks and Permissions**



HUAWEI and other Huawei trademarks are trademarks of Huawei Technologies Co., Ltd.

All other trademarks and trade names mentioned in this document are the property of their respective holders.

## **Notice**

The purchased products, services and features are stipulated by the contract made between Huawei and the customer. All or part of the products, services and features described in this document may not be within the purchase scope or the usage scope. Unless otherwise specified in the contract, all statements, information, and recommendations in this document are provided "AS IS" without warranties, guarantees or representations of any kind, either express or implied.

The information in this document is subject to change without notice. Every effort has been made in the preparation of this document to ensure accuracy of the contents, but all statements, information, and recommendations in this document do not constitute a warranty of any kind, express or implied.

## **Huawei Technologies Co., Ltd.**

Address: Huawei Industrial Base  
Bantian, Longgang  
Shenzhen 518129  
People's Republic of China

Website: <http://e.huawei.com>

# About This Document

## Overview

This document describes the basic functions and operations of the Smart PV Management System.

## Product Version

System Name	Product Version
Smart PV Management System	V300R006C00



## Intended Audience




This document is intended for:

- System engineers
- Network shift engineers
- Network management engineers
- Service operation personnel
- Service administrator
- Field engineers

## Symbol Conventions

The symbols that may be found in this document are defined as follows:

Symbol	Description
	Indicates an imminently hazardous situation which, if not avoided, will result in death or serious injury.
	Indicates a potentially hazardous situation which, if not avoided, could result in death or serious injury.

Symbol	Description
	Indicates a potentially hazardous situation which, if not avoided, may result in minor or moderate injury.
	Indicates a potentially hazardous situation which, if not avoided, could result in equipment damage, data loss, performance deterioration, or unanticipated results. NOTICE is used to address practices not related to personal injury.
	Calls attention to important information, best practices and tips. NOTE is used to address information not related to personal injury, equipment damage, and environment deterioration.

## Change History

Issue	Date	Description
02	2019-05-30	This is the second commercial release. Compared with the previous version, this version includes the following changes: <ul style="list-style-type: none"> <li>• Added <a href="#">5.4 Exporting Device Information</a></li> <li>• Modified <a href="#">1.5 Roles and Permissions</a></li> <li>• Modified <a href="#">1.2 Login and Logout</a></li> <li>• Added <a href="#">8.1 How Do I Disable the Remote Control Function?</a></li> </ul>
01	2019-01-30	This is the first commercial release.

---

# Contents

---

<b>About This Document</b> .....	<b>ii</b>
<b>1 Start Guide</b> .....	<b>1</b>
1.1 Installer Registration.....	1
1.2 Login and Logout .....	6
1.3 GUI Description.....	9
1.3.1 Multi-Plant Interface.....	9
1.3.2 Single-Plant Interface .....	11
1.3.3 Dashboard Interface.....	13
1.4 Initial Configuration .....	16
1.5 Roles and Permissions .....	16
<b>2 System Settings</b> .....	<b>24</b>
2.1 Account Settings .....	25
2.2 Plant Management .....	26
2.3 Company Management.....	31
2.4 Role Management.....	35
2.5 User Management.....	37
2.6 Upgrade Management.....	40
2.7 Collector Management.....	41
2.8 Log Export.....	43
2.9 Enterprise Information Management .....	44
2.10 Device License Management.....	46
<b>3 System Public Notices</b> .....	<b>50</b>
3.1 Viewing Public Notices .....	50
3.2 Sending Public Notices.....	51
<b>4 Plant Layout</b> .....	<b>53</b>
4.1 Creating a Physical Layout .....	53
4.2 Viewing the Plant Layout.....	57
<b>5 Device Management</b> .....	<b>58</b>
5.1 Setting Device Parameters.....	58
5.2 Modifying or Deleting a Device .....	61
5.3 Replacing a Device .....	62

---

5.4 Exporting Device Information .....	63
5.5 Viewing Device Details .....	64
<b>6 Intelligent O&amp;M.....</b>	<b>69</b>
6.1 Real-Time Status.....	69
6.1.1 Viewing Plant Status .....	69
6.1.2 Viewing a Plant Map.....	71
6.1.3 Viewing Real-Time Alarms of a Plant .....	72
6.2 Device Alarm Management .....	74
6.3 Fault Recovery Management .....	74
6.4 IV Curve .....	78
<b>7 Report Management .....</b>	<b>83</b>
<b>8 FAQs .....</b>	<b>86</b>
8.1 How Do I Disable the Remote Control Function? .....	86

---

# 1 Start Guide

---

This chapter describes the basic operations and GUI layout of the system.

## 1.1 Installer Registration

This section describes how to register an account before the first login.

## 1.2 Login and Logout

This section describes how to log in to and out of the Smart PV Management System.

## 1.3 GUI Description

This section describes the layout and functions of the main interfaces of the Smart PV Management System.

## 1.4 Initial Configuration

Before managing plant information, you need to perform initial configuration for the Smart PV Management System.

## 1.5 Roles and Permissions

This section describes the default permissions of the installer registration role, Residential user role, and guest role.

## 1.1 Installer Registration

This section describes how to register an account before the first login.

### Procedure

- Step 1** Open Internet Explorer, enter <https://intl.fusionsolar.huawei.com>, and press Enter. The login page is displayed.
- Step 2** (Optional) From the drop-down list in the upper right corner of the page, select the language.

**Figure 1-1** Login page

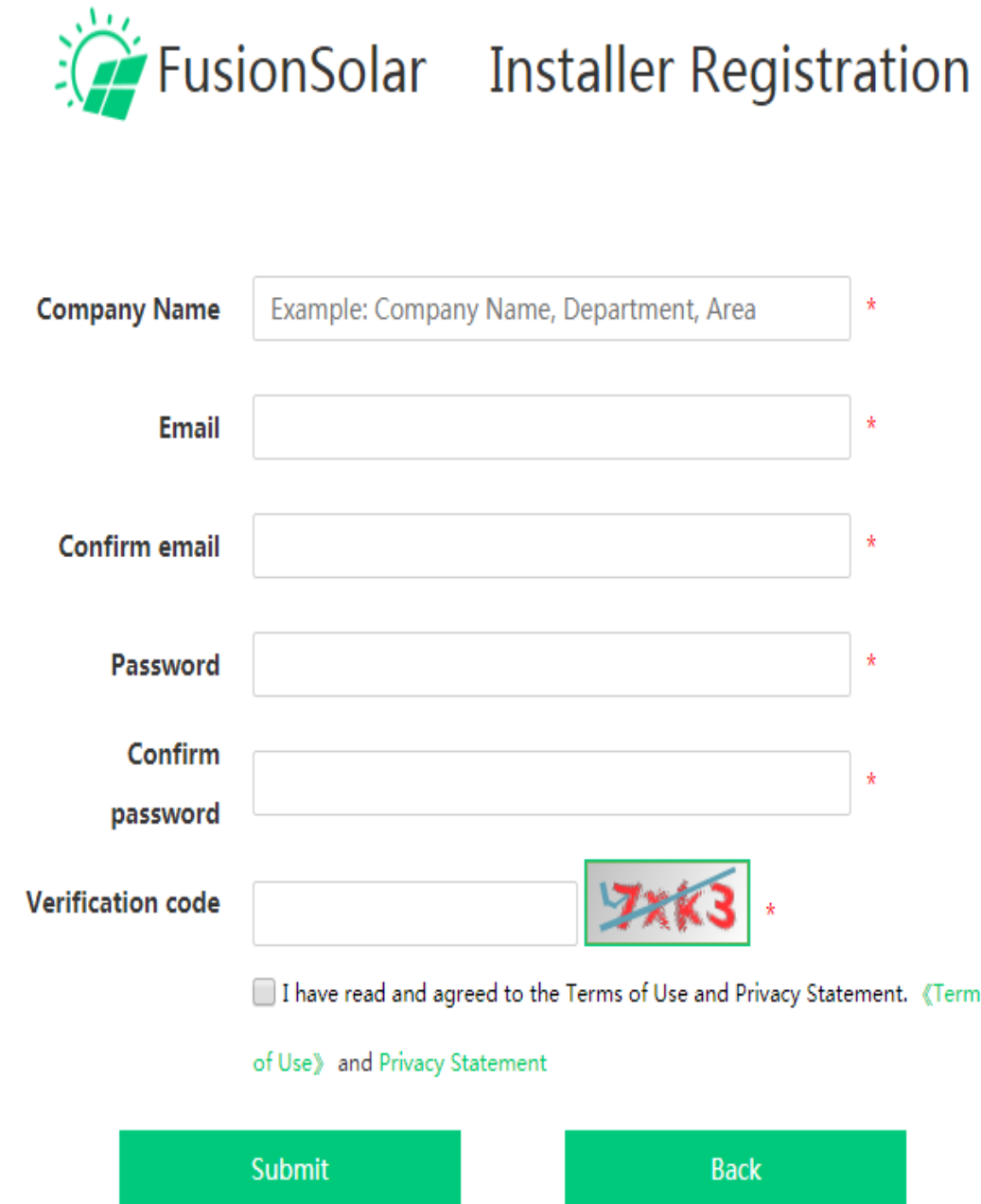


**Step 3** Click **Installer Registration**. The **Installer Registration** page is displayed.

**Step 4** Set registration information.



Figure 1-2 Installation registration



The image shows a registration form for FusionSolar. At the top left is the FusionSolar logo, which consists of a green sun icon with rays and a green square with a white diagonal line. To the right of the logo is the text "FusionSolar" in a large, bold, black font, followed by "Installer Registration" in a slightly smaller, bold, black font. Below the header is a registration form with several input fields and a checkbox. The fields are: "Company Name" with a placeholder "Example: Company Name, Department, Area", "Email", "Confirm email", "Password", "Confirm password", and "Verification code". Each field has a red asterisk to its right. The "Verification code" field is currently empty, and to its right is a small image of a verification code "7xk3" with a red 'X' over it. Below the fields is a checkbox with the text "I have read and agreed to the Terms of Use and Privacy Statement." followed by a link "Terms of Use" and "and Privacy Statement". At the bottom of the form are two green buttons: "Submit" and "Back".

 **NOTE**

- During registration, record the mailbox and password, which will be used for system login.
- The rules for setting the company name and password are as follows:
- The company name contains 1 to 60 characters and cannot be null. The following special characters are not allowed: '|<>,&'
- 1. The password must be 8 to 32 characters and contain at least two types of the following characters: uppercase letters, lowercase letters, digits, and special characters except the following: '~!@#\$\$%^&\*()-\_+=\|[{ }]. ''',<.>/?'

**Step 5** The system checks whether the company name exists.

- If no, fill in the registration information and perform [Step 8](#) to [Step 9](#).
- If yes, perform [Step 6](#) to [Step 9](#) to apply for an account from the company administrator.

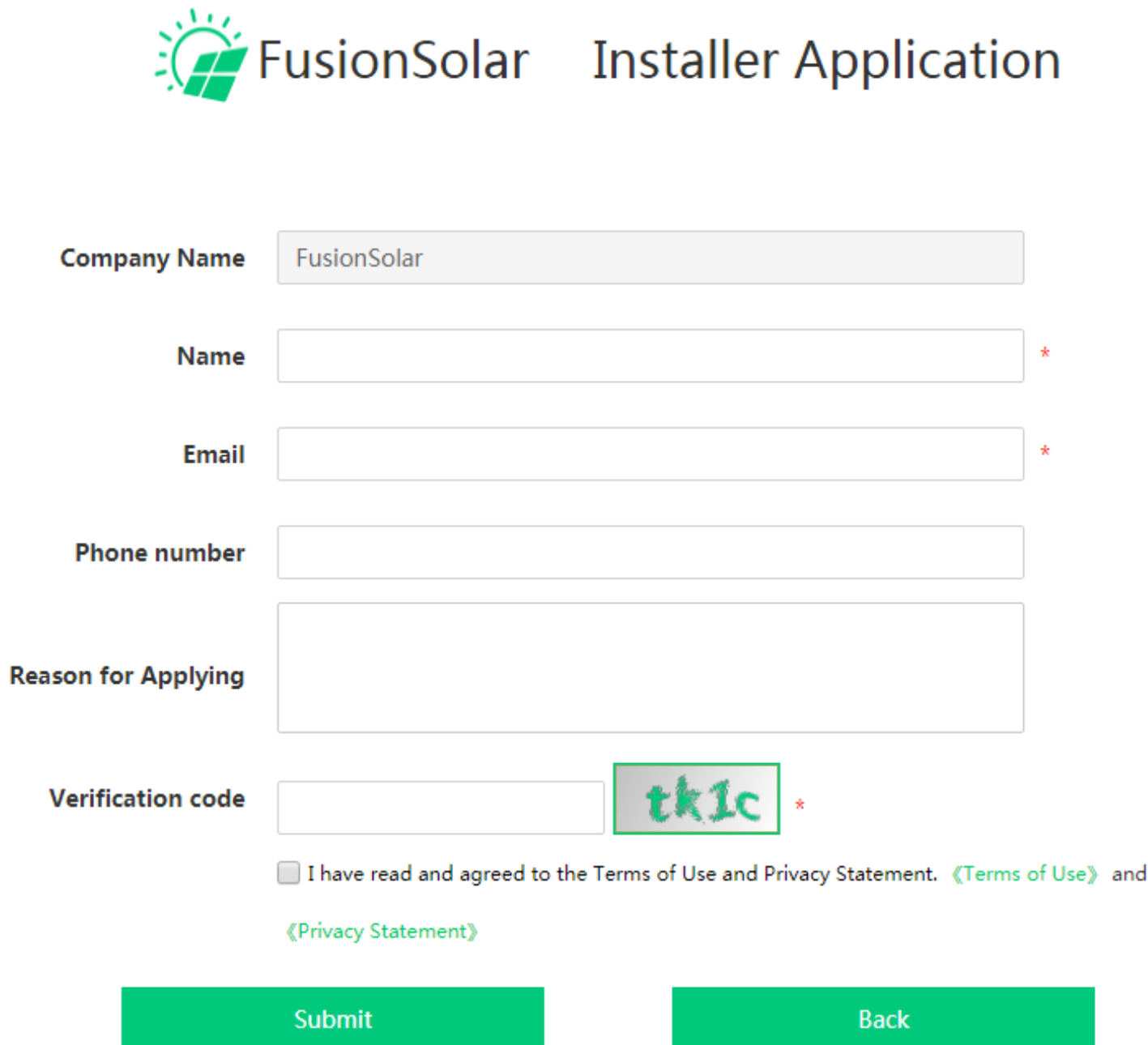
**Step 6** Click **Account Application**. The **Installer Application** page is displayed.

**Figure 1-3** Applying for an account



**Step 7** Fill in the application information.

Figure 1-4 Installer application



The screenshot shows the 'FusionSolar Installer Application' registration form. At the top left is the FusionSolar logo, which consists of a green sun icon with rays and a green solar panel icon. To the right of the logo, the text 'FusionSolar' and 'Installer Application' are displayed in a large, dark font. Below the header, the form contains several input fields and a checkbox:

- Company Name:** A text input field containing the value 'FusionSolar'.
- Name:** An empty text input field with a red asterisk (\*) to its right, indicating it is a required field.
- Email:** An empty text input field with a red asterisk (\*) to its right, indicating it is a required field.
- Phone number:** An empty text input field.
- Reason for Applying:** A large, empty text area for providing details.
- Verification code:** A text input field followed by a green box containing the code 'tk1c' and a red asterisk (\*) to its right, indicating it is a required field.
- Terms and Privacy Statement:** A checkbox followed by the text 'I have read and agreed to the Terms of Use and Privacy Statement. <a href="#">Terms of Use</a> and <a href="#">Privacy Statement</a>'. The links are in green.

At the bottom of the form, there are two large green buttons: 'Submit' on the left and 'Back' on the right.



**NOTE**

Ask the installation personnel to fill in the actual information. After the application is submitted, the system sends an email to the company administrator. After the application is approved by the administrator, create an account for the installation.

**Step 8** Select **I have read and agreed to the Terms of Use and Privacy Statement**. Then, click **Submit**.

**Step 9** In the displayed dialog box, click **OK** to return to the login page.

After the registration is successful, log in to the mailbox and activate the account as prompted. After the activation, log in to the system by using the mailbox and password.



**NOTE**

After the system login, the system automatically generates an installer's account. You can use this account to log in to the management system.

----End

## 1.2 Login and Logout

This section describes how to log in to and out of the Smart PV Management System.

### Prerequisites

You have obtained the user name (or mailbox or mobile phone number) and password for logging in to the system.

### Context

The following configuration is recommended for the PC used for logging in to the Smart PV Management System.

Item	Description
PC	<ul style="list-style-type: none"><li>• CPU: Intel quad-core CPU of 2.6 GHz or higher</li><li>• Memory: 4 GB or larger</li><li>• Hard disk: Free space of 40 GB or more hard disks after the OS installation</li><li>• Resolution: 1366 x 768 or higher</li><li>• OS: Mainstream operating system</li></ul>

### Procedure

- Logging in to the system
  - a. Open Internet Explorer, enter <https://intl.fusionsolar.huawei.com>, and press Enter.
  - b. (Optional) From the drop-down list in the upper right corner of the page, select the site and language for logging in to the system.
  - c. Enter the user name (or mailbox or mobile phone number) and password, and click **Login** or press **Enter**.

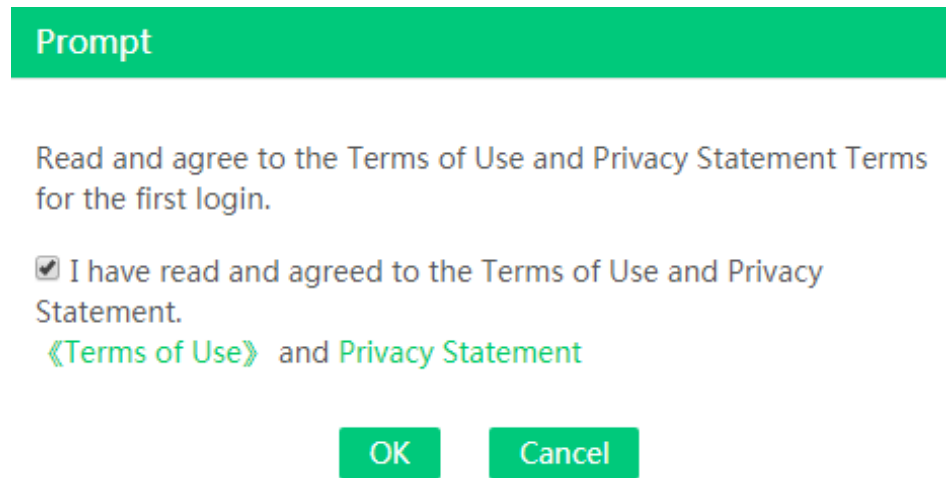
**Figure 1-5** Login page



 **NOTE**

- If no user account is available, click **Guest Login** to log in to the system as a guest. Guests can only browse some functions of the system.
  - If you forget the password, click **Forgot Password**, reset the password as prompted, and use the new password to log in to the system.
  - An account can be used to log in to one web client and one app at the same time.
  - If a user enters incorrect passwords (or verification codes) for the same account for  $M$  consecutive times or enters incorrect passwords (or verification codes) for  $2 \times M$  consecutive times, the login IP address will be locked for  $N$  minutes. The initial value of  $M$  is **5**, and the initial value of  $N$  is **30**.
- d. (Optional) If a new user logs in to the system for the first time or uses updated terms or privacy policies to log in to the system for the first time, the user must agree to the terms of use and privacy terms to log in to the system, as shown in Figure 1-6. In addition, the new user must change the password immediately after login.

**Figure 1-6** Login prompt



**NOTICE**

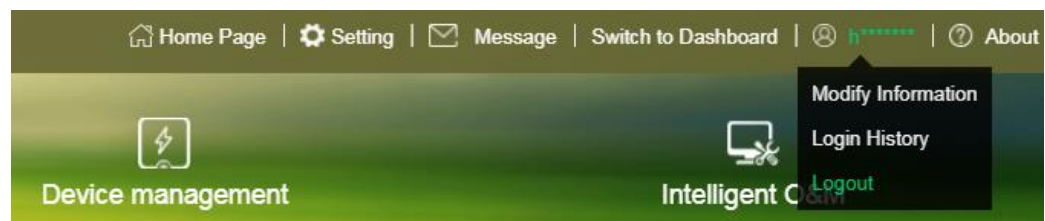
To ensure account security, you are advised to change the password periodically and bear the new password in mind. The initial password, if not changed, may be leaked. A password left unchanged for a long period of time may be stolen or cracked. If a password is lost, systems cannot be accessed. In these cases, the user is liable for any loss caused to the PV plant.

**NOTE**

You can log in to the system after successful login. Before using the system, check the following:

- After successful login, the system displays the latest five login details of the current user, including the login IP address, login attempts, password validity period, login time, client, and result.
- No pop-up window will be displayed in the system.
- Do not change the local PC IP address during the operation. Otherwise, you will be forced to log out of and then log in to the system again.
- Canceling login  
On the home page, move the mouse cursor to user name in the personnel center area and choose **Logout** from the drop-down list.

**Figure 1-7** Logout



**NOTE**

This operation is for logout only. If you need to exit from the system completely, close the system in the browser.

## 1.3 GUI Description

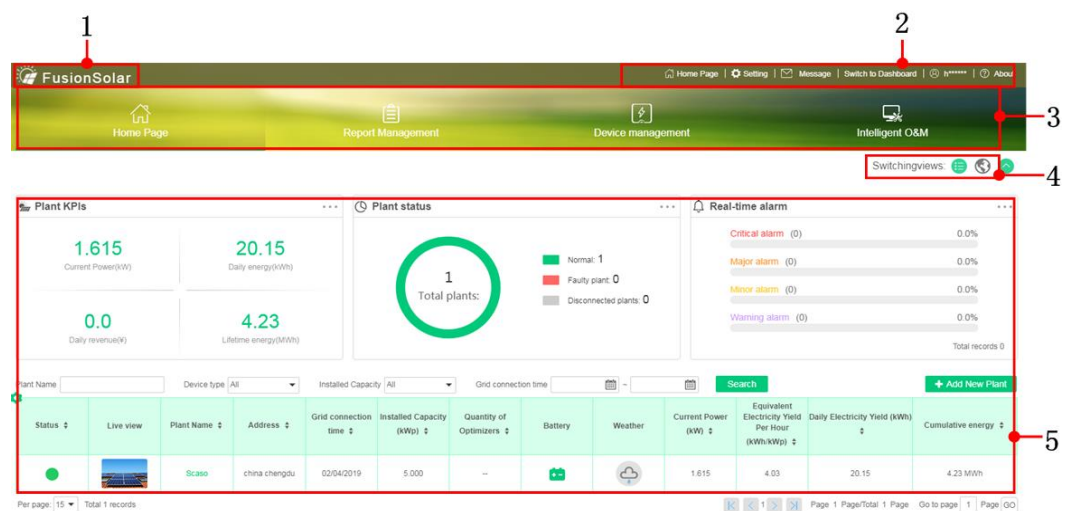
This section describes the layout and functions of the main interfaces of the Smart PV Management System.

### 1.3.1 Multi-Plant Interface

This section describes the GUI layout and functions of the multi-plant interface.




The multi-plant interface includes the system logo and title, function tab area, personal center area, view switching area, and comprehensive information area. Figure 1-8 shows the default system interface.

**Figure 1-8** Multi-plant interface



**Table 1-1** Descriptions about the multi-plant interface

No.	Item	Description
1	System logo and title	<p>This area displays the logo and title of the Smart PV Management System.</p> <p>After system login, you can click the system name on any page to return to the home page.</p> <p>You can change the logo and title. For details, see 2.9 Enterprise Information Management.</p>
2	Personal center	<p>The components in the personal center area are described as follows:</p> <ul style="list-style-type: none"> <li>• <b>Home Page:</b> On any page, click <b>Home Page</b> to return to the home page.</li> <li>• <b>Setting:</b> Click <b>Setting</b>. The <b>System Settings</b> page is displayed. For details about system settings, see 2 System Settings.</li> <li>• <b>Message:</b> Click <b>Message</b>. The <b>Public Notice</b> page is displayed. For details about public</li> </ul>

No.	Item	Description
		<p>notices, see 3 System Public Notices.</p> <ul style="list-style-type: none"> <li>• <b>Switch to Dashboard:</b> Click <b>Switch to Dashboard</b>. The Dashboard page is displayed. For details about the Dashboard, see 1.3.3 Dashboard Interface.</li> <li>• <b>User name:</b> This area displays the current login user name. You can move the mouse cursor to the user name to select operations, including modifying the personal information, viewing the latest login information, and logging out of the system.</li> <li>• <b>About:</b> Move the mouse cursor to <b>About</b> to view the online help documents, terms, privacy policies, and version information of the current system.</li> </ul>
3	Function menu	<p>The main functions of the Smart PV Management System are as follows:</p> <ul style="list-style-type: none"> <li>• <b>Home Page</b> <ul style="list-style-type: none"> <li>– <b>List View:</b> <b>List View</b> is displayed by default after the home page is entered. Click  in the <b>Plant KPIs</b> area. The <b>Plant Report</b> page is displayed. Click  to display only the plant list. Click  in the upper left corner of the list to set the columns to be displayed. Click a target plant to enter the single-plant interface. For details about the single-plant interface, see 1.3.2 Single-Plant Interface.</li> <li>– <b>Map View:</b> You can intuitively view the location of a plant in this mode. Click the plant image to view the basic and weather information of the plant.</li> </ul> </li> <li>• <b>Report Management:</b> For details, see 7 Report Management.</li> <li>• <b>Device Management:</b> For details, see 5 Device Management.</li> <li>• <b>Intelligent O&amp;M:</b> For details, see 6 Intelligent O&amp;M.</li> </ul>
4	View switching	List view and map view are provided. Click the corresponding icon to switch the view.
5	Comprehensive information	The information displayed in the comprehensive information area varies according to the function menu.



### 1.3.2 Single-Plant Interface

This section describes the GUI layout and functions of a single-plant interface.

In the plant list view, click a plant name to open the single-plant interface, as shown in Figure 1-9.

The GUI layout and functions of a single-plant interface are similar to those of a multi-plant interface. The only difference is that the data and operations on the GUI are applicable only to the current plant.

Figure 1-9 Single-plant interface

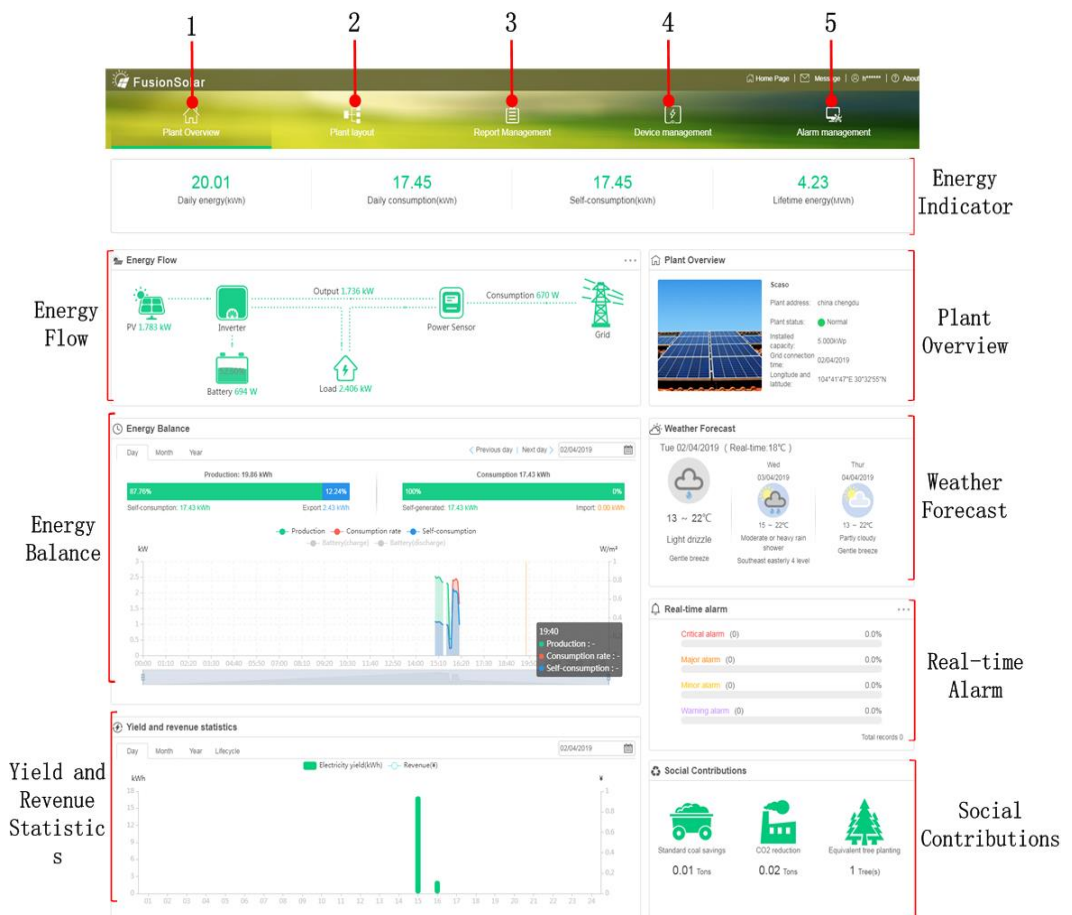




Table 1-2 lists main functions of the single-plant interface.

Table 1-2 Main functions of the single-plant interface

No.	Item	Description
1	Plant Overview	<p>This interface displays the power indicators, power flow, basic information, power management, weather forecast, social contributions, energy yield and revenue statistics, and real-time alarms.</p> <ul style="list-style-type: none"> <li>Energy indicators: Displays the daily energy yield, daily energy consumption, self-consumption energy, and cumulative</li> </ul>

No.	Item	Description
		<p>energy of the current plant.</p> <ul style="list-style-type: none"> <li>• Energy flow: Displays the energy direction in graphics.</li> <li>• Plant overview: Displays the plant address, plant status, installed capacity, grid connection time, and longitude and latitude.</li> <li>• Energy management: Displays the daily, monthly, and yearly energy yields and power consumption of the plant; Displays the energy power, consumption power, and charging and discharging power of the battery.</li> <li>• Weather forecast: Displays the weather conditions of the current day and the next two days.</li> <li>• Real-time alarm: Displays the number and proportion of different-severity alarms of the current plant.</li> <li>• Yield and revenue statistics: Displays the daily, monthly, yearly, and lifecycle energy yield and revenue statistics of the plant.</li> <li>• Social contributions: Displays the environmental benefits of the current plant, including carbon dioxide emission reduction, standard coal conservation, and equivalent plant tree quantity.</li> </ul> <p><b>NOTE</b></p> <ul style="list-style-type: none"> <li>• In the <b>Energy Flow</b> area, the following operations are allowed:</li> <li>• For a Residential plant with only one Smart Energy Center, click  or click an inverter to switch to the <b>Real-time Information</b> page of the inverter. In other cases, you can switch to the <b>Device Management</b> page by performing the same operations.</li> <li>• Move the mouse cursor to devices such as an inverter, a Battery, and a meter to view device specifications.</li> <li>• In the <b>Energy Management</b> area, the following operations are allowed:</li> <li>• Click <b>Day</b>, <b>Month</b>, or <b>Year</b>, and set the time to view the energy indicators of the plant in different time periods.</li> <li>• Drag the bottom time axis to set the time range of the statistical chart.</li> <li>• In the <b>Yield and Revenue Statistics</b> area, click <b>Day</b>, <b>Month</b>, <b>Year</b>, or <b>Lifecycle</b>, and set the specific time to view the energy yield and revenue statistics of the plant in different time segments.</li> <li>• In the <b>Real-time Alarm</b> area, click  The <b>Device Alarm</b> page is displayed.</li> </ul>
2	Plant Layout	For details, see 4 Plant Layout.
3	Device Management	For details, see 5 Device Management.
4	Alarm Management	For details, see 6.2 Device Alarm Management.
5	Report	For details, see 7 Report Management.

No.	Item	Description
	Management	

### 1.3.3 Dashboard Interface

This section describes the GUI layout and functions of the Dashboard interface.

Dashboard is classified into company-level information display and plant-level information display. A user who has the Dashboard display permission can access the Dashboard.

- On the Smart PV Management System interface, click **Switch to Dashboard** in the upper right corner. The company-level smart cloud center is displayed by default, as shown in Figure 1-10.
- On the company-level Dashboard, you can click a plant under a level-2 company in the plant map to enter the plant-level Dashboard, as shown in Figure 1-11.

Figure 1-10 Dashboard (company-level)

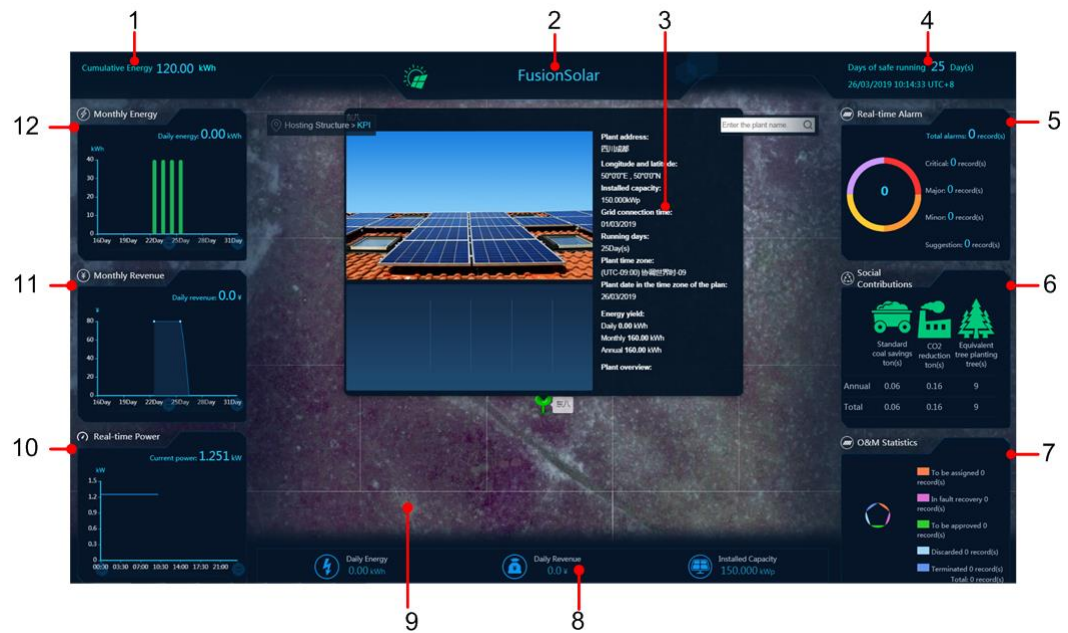


Table 1-3 Descriptions about company-level Dashboard

No.	Component Name	Description
1	Cumulative energy	Displays the accumulated energy yield of all plants under the company that the current login user belongs to.
2	Logo and title	Displays the logo and title of the Dashboard. The logo and title can be modified. For details, see 2.9 Enterprise

No.	Component Name	Description
		<p>Information Management.</p> <p>Click the logo or title to return to the Smart PV Management System interface.</p>
3	Days of safe running	<p>Displays the safe running days and current time of the company. This item is calculated based on the safe running start date set during company creation. For details about how to create a company, see 2.3 Company Management.</p>
4	Energy yield ranking	<p>Displays the top-10 plants and their energy yields of the current company.</p>
5	O&M statistics	<p>Displays the fault recovery flows of all plants of the current company.</p>
6	Real-time alarm	<p>Displays the total number of alarms of all plants and the number of alarms of each severity of the current company.</p>
7	Plant information	<p>Displays the installed capacity, current power, current revenue, and current energy yield of the plant.</p>
8	Plant map	<p>Displays the locations of all plants of the current company.</p>
9	Weather	<p>Displays the weather in the area where all plants of the company are located in turn.</p>
10	Social contributions	<p>Displays the environmental benefits of all plants of the company, including carbon dioxide emission reduction, standard coal conservation, and equivalent plant tree quantity.</p>
11	Energy yield and revenue	<p>Displays the energy yield, revenue bar chart, and daily energy yield.</p> <p>Drag the time axis to display data in the corresponding time segment.</p>
12	Real-time power	<p>Displays the real-time power and current power.</p> <p>Drag the time axis to display data in the corresponding time segment.</p>

**Figure 1-11** Dashboard (plant level)



**Table 1-4** Descriptions about the plant-level Dashboard

No.	Component Name	Description
1	Cumulative energy	Displays the accumulated plant energy yield of the company.
2	Logo and title	Displays the Dashboard logo and title of the company that a user belongs to. For details about how to change the logo and title, see 2.9 Enterprise Information Management. Click the logo or title to return to the multi-plant home page.
3	Plant details	Displays the details and the weather of the plant.
4	Days of safe running	Displays the safe running days and current time of the company. This item is calculated based on the safe running start date set during company creation. For details about how to create a company, see 2.3 Company Management.
5	Real-time alarm	Displays the total number of alarms of the current plant and the number of alarms of each severity.
6	Social contributions	Displays the environmental benefits of the current plant, including carbon dioxide emission reduction, standard coal conservation, and equivalent plant tree quantity.
7	O&M statistics	Displays the fault recovery flows of the current plant.

No.	Component Name	Description
8	Plant information	Displays the daily energy yield, daily revenue, and installed capacity of the current plant.
9	Plant map	Displays the current plant map.
10	Real-time power	Displays the real-time and current power of the plant.
11	Monthly revenue	Displays the monthly and daily revenues. Drag the time axis to display data in the corresponding time segment.
12	Monthly energy	Displays the monthly and daily energy yield of the current plant. Drag the time axis to display data in the corresponding time segment.

## 1.4 Initial Configuration

Before managing plant information, you need to perform initial configuration for the Smart PV Management System.

- **Modifying personal information:** To improve personal information and guarantee system security, you need to modify your personal information in time after login. For details, see 2.1 Account Settings.
- **Creating a company structure:** Create a company structure according to the actual situation. The permissions of roles, users, and plants can be isolated by the company structure. For details, see 2.3 Company Management.
- **Creating a role:** Create a role based on the site requirements and assign the role to the user to control user permissions. For details, see 2.4 Role Management.
- **Creating a user:** Create a user for logging in to the system. For details, see 2.5 User Management.
- **Adding a plant:** Connect the plant to the system. For details, see 2.2 Plant Management.

## 1.5 Roles and Permissions

This section describes the default permissions of the installer registration role, Residential user role, and guest role.

**Table 1-5** Role permission reference

Layer 1	Layer 2	Layer 3	Layer 4	Layer 5	Installer	Owner	Guest
System configuration					√	√	x

Layer 1	Layer 2	Layer 3	Layer 4	Layer 5	Installer	Owner	Guest
	Collector management				√	x	x
		Collector management			√	x	x
	Log export				√	x	x
	Upgrade management				√	x	x
		Device upgrade			√	x	x
	Plant management				√	√	x
		Plant information settings			√	√	x
			Plant creation		√	x	x
			Plant information update		√	√	x
				Basic information	√	√	x
				Access device/Composition details	√	x	x
				Electricity price settings	√	√	x
				Other information	√	√	x
			Plant information deletion		√	x	x
	Account settings				√	√	x
	Enterprise				√	x	x

Layer 1	Layer 2	Layer 3	Layer 4	Layer 5	Installer	Owner	Guest
	information						
	License management				√	x	x
		Device license management			√	x	x
	Role management				√	x	x
		Role addition			√	x	x
		Role modification			√	x	x
		Role deletion			√	x	x
		Role search			√	x	x
	User management				√	x	x
		User addition			√	x	x
		User information modification			√	x	x
		User search			√	x	x
		Company information modification			√	x	x
		Reset			√	x	x
		Company deletion			√	x	x
		Adding a Residential user			√	x	x



Layer 1	Layer 2	Layer 3	Layer 4	Layer 5	Installer	Owner	Guest
		Disabling a user			√	x	x
		Enabling a user			√	x	x
		User deletion			√	x	x
		Company creation			√	x	x
Home page					√	√	√
	Home page of the plant list				√	√	√
	Home page of the plant map				√	√	√
Intelligent O&M					√	x	x
	Real-time status				√	x	x
	Alarm management				√	x	x
		Device alarm			√	x	x
	Task management				√	x	x
		Fault recovery management			√	x	x
	Intelligent diagnosis				√	x	x
		IV curve			√	x	x
Report management					√	x	x
Device management					√	√	√

Layer 1	Layer 2	Layer 3	Layer 4	Layer 5	Installer	Owner	Guest
	PV area				√	√	√
		Modification			√	x	x
		Parameter settings			√	x	x
		Deletion			√	x	x
		Device replacement			√	x	x
		Device details			√	√	√
			Device teleadjust		√	x	x
			Device information		√	√	√
			Alarm information		√	x	x
			Historical information		√	√	√
			Optimizer		√	x	x
		Export			√	x	x
System public notice					√	√	x
	Public notice				√	√	x
	Sending public notices				√	x	x
Dashboard display					√	x	x
	Company-level display				√	x	x
		Real-time power			√	x	x
		Energy			√	x	x

Layer 1	Layer 2	Layer 3	Layer 4	Layer 5	Installer	Owner	Guest
		yield and revenue					
		Social contributions			√	x	x
		Energy yield ranking			√	x	x
		O&M statistics			√	x	x
		Real-time alarm			√	x	x
	Plant-level display				√	x	×
		Monthly energy			√	x	x
		Monthly revenue			√	x	x
		Real-time power			√	x	x
		Real-time alarm			√	x	x
		Social contributions			√	x	x
		O&M statistics			√	x	x
Single-plant home page					√	√	√
	Real-time alarm				√	√	√
	Plant layout				√	x	√
		Physical view edit			√	x	x
		Physical view deletion			√	x	x
		Drawing upload			√	x	x

Layer 1	Layer 2	Layer 3	Layer 4	Layer 5	Installer	Owner	Guest
		Drawing deletion			√	x	x
App					√	√	√
	Home page				√	√	√
		Plant layout			√	x	√
		Daily ranking of top plants			√	x	x
		Yield and revenue statistics			√	√	√
		Social contributions			√	√	√
		Plant status			√	x	x
		Real-time alarm			√	x	x
	O&M				√	x	x
		Device alarm			√	x	x
		Mobile O&M			√	x	x
			Fault recovery management		√	x	x
		IV curve			√	x	x
	Device management				√	√	√
		Parameter settings			√	x	x
		Device replacement			√	x	x
		Device details			√	√	√
			Real-time informatio		√	√	√

Layer 1	Layer 2	Layer 3	Layer 4	Layer 5	Installer	Owner	Guest
			n				
				Optimizer positioning	√	x	x
			Device information		√	√	√
			Alarm information		√	x	x
			Historical information		√	x	x
	Plant deployment				√	x	x
		Plant management			√	x	x
		User management			√	x	x
		Device commissioning			√	x	x

# 2 System Settings

---

System settings include account settings, plant management, role settings, user management, upgrade management, collector management, log export, enterprise information management, and device license management.

## [2.1 Account Settings](#)

This section describes how to modify the personal information about the user that has logged in to the system.

## [2.2 Plant Management](#)

This section describes how to create, modify, and delete a plant.

## [2.3 Company Management](#)

This section describes how to create a company structure in a hosting center.

## [2.4 Role Management](#)

This section describes how to add, modify, and delete a role.

## [2.5 User Management](#)

This section describes how to add, modify, delete, enable, and disable a user.

## [2.6 Upgrade Management](#)

This section describes how to upgrade the device.

## [2.7 Collector Management](#)

This section describes how to view and manage the devices connected to the Smart Dongle and SmartLogger 1000A.

## [2.8 Log Export](#)

This section describes how to export device logs and save the logs to a local PC.

## [2.9 Enterprise Information Management](#)

This section describes how to set the system logo, title, enterprise information, and mailbox.

## [2.10 Device License Management](#)

This section describes how to view device license information and how to apply for, load, and revoke a device license.

## 2.1 Account Settings

This section describes how to modify the personal information about the user that has logged in to the system.

### Context

- The new password cannot be the same as the historical passwords set in specified times of password modifications. To configure the historical password setting times, contact the system administrator.
- After the password is changed, the password cannot be changed again within the minimum validity period. If the password exceeds the maximum validity period, the password must be changed after successful login to the system. The default minimum validity period is 1440 minutes and the default maximum validity period is 90 days.

### Procedure

**Step 1** Access the **Account Settings** page through either of the following methods:

- On the top of the home page, click **Setting**.
- Move the mouse cursor to a name in the personnel center area and then choose **Modify Information** from the drop-down list.

**Step 2** Click **Modify** next to the information to be modified.

**Figure 2-1** Account settings

The screenshot shows the 'Account Settings' interface. On the left, a sidebar titled 'System Settings' lists various options, with 'Account Settings' highlighted in green. The main area contains five rows of settings, each with a text input field and a 'Modify' button to its right:

- User name: [input field with 'h\*\*\*\*\*'] Modify
- User avatar: [input field with a person icon] Modify
- Password: [input field with '\*\*\*\*\*'] Modify
- Telephone: [input field] Modify
- Email: [input field with 'hjh\*@huawei.com'] Modify



#### NOTE

The rules for setting the user name and password are as follows:

- The user name contains 6 to 32 characters, including case insensitive letters, digits, and special characters (@, ., -, and \_).
- The password contains at least 8 to 32 characters, including at least two types of the following characters: uppercase letters, lowercase letters, digits, and special characters.
- The user name and password must be different.
- The avatar size cannot exceed 512 KB. Only JPG, .PNG, JPEG, and BMP formats are supported.

After the user name and password are changed, the current user is forced to log out of the system. The system can be used only after re-login.

----End

## 2.2 Plant Management

This section describes how to create, modify, and delete a plant.

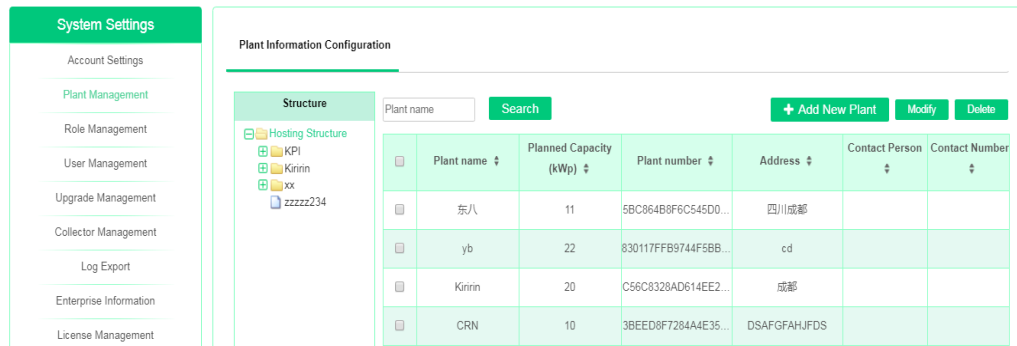
### Prerequisites

You have obtained the information about the access device, including the SN or IP address.

### Adding a Plant

- Step 1** On the home page, click **Setting**. The **System Settings** page is displayed.
- Step 2** In the navigation tree on the left, click **Plant Management**. The company structure and the plant list of the hosting center are displayed.

**Figure 2-2** Plant management



- Step 3** Click **Add New Plant**. The **Add New Plant** dialog box is displayed.



**Figure 2-3** Basic information

The screenshot shows a web interface for adding a new plant. At the top, there is a green header bar with the text "Add New Plant" and a close button (X). Below the header, there are five tabs: "Basic Information", "Access Device", "String Configuration", "Electric Price Configuration", and "Other Information". The "Basic Information" tab is currently selected and highlighted. The form contains the following fields:

- Plant ownership:** A text input field with a red asterisk and a help icon (question mark in a circle) to its right.
- Plant name:** A text input field with a red asterisk to its right.
- DC capacity:** A text input field with the placeholder text "Sum of component power under STC conditions" and a red asterisk with "kWp" to its right.
- Grid connection time:** A date picker input field with a red asterisk and a calendar icon to its right.
- Contact Person:** A text input field.
- Contact Number:** A text input field.

At the bottom of the form, there are two green buttons: "Next" and "Cancel".

**Step 4** Set basic plant information.


**Step 5** Click **Next**. The **Access Device** tab page is displayed. Set the access device of the plant.

**Figure 2-4** Access device configuration

The screenshot shows a web interface for adding a new plant. At the top is a green header bar with the text 'Add New Plant' and a close button 'x'. Below the header is a navigation bar with five tabs: 'Basic Information', 'Access Device' (which is selected and underlined), 'String Configuration', 'Electric Price Configuration', and 'Other Information'. To the right of the tabs is a green '+ Add' button. Below the tabs is a form with three input fields: 'Device SN', 'Device name', and 'Version'. The 'Device SN' field has a green question mark icon to its right. The 'Device name' field has a green question mark icon to its right. The 'Version' field has a red 'x' icon to its right. Below the form are three green buttons: 'Previous', 'Next', and 'Cancel'.


1. Enter the device SN.

 **NOTE**

- The SN can contain only 12, 17, or 20 characters.
- Enter the device SN. The system automatically displays the device name, version, and connected devices of the device.
- Click  next to SN to view all inverters connected to the SmartLogger.

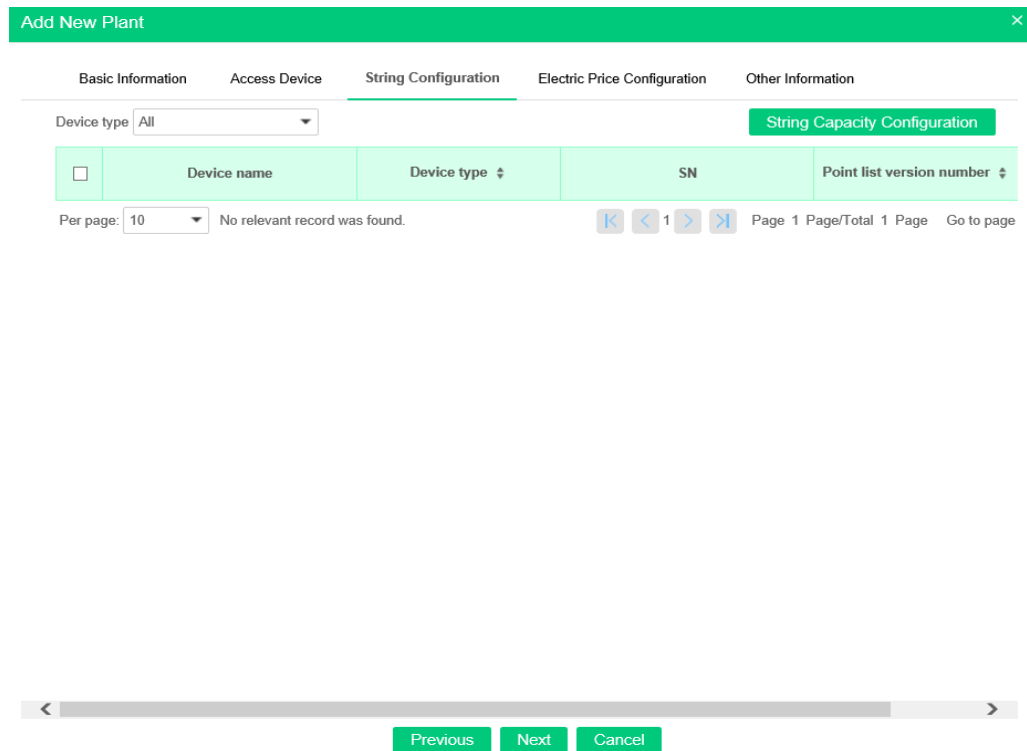
2. Click **Add**. Repeat the preceding steps to add more devices.

 **NOTE**

- Click  to unbind a device.

**Step 6** Click **Next**. The **String Configuration** tab page is displayed. Set the string capacity.

**Figure 2-5** String settings



In the device list, select one or more devices to be configured and click **String Capacity Configuration**.

 **NOTE**

- By default, the system allocates the string capacity based on the configured DC capacity. You can set the actual string capacity based on the plant access situation.
- Select devices of the same type during batch configuration.
- If **Batch configuration** is selected, the capacity of other strings to be configured is automatically set to the same value as PV1 after PV1 capacity parameters are configured.

**Step 7** Click **Next**. The **Electric Price Configuration** tab page is displayed. Set the feed-in electricity price and purchasing electricity price.

**Figure 2-6** Electricity price settings

The screenshot shows the 'Add New Plant' interface with the 'Electric Price Configuration' tab selected. It features a table for setting electricity prices with columns for date range (DD/MM), time range, and price (CNY/kWh). A green '+' button is used to add multiple time-of-use electricity prices in a day, and a red '-' button is used to delete the corresponding time-of-use electricity price. An 'Add' button is also present. At the bottom, there are 'Previous', 'Next', and 'Cancel' buttons.

1. The setting of the feed-in electricity is used as an example. Set the start date and end date, and enter the electricity price.

**NOTE**

- Click to add multiple time-of-use electricity prices in a day.
- Click to delete the corresponding time-of-use electricity price.

2. (Optional) Click **Add** to add the time-of-use electricity prices in multiple date ranges.

**NOTE**

- The sum of multiple date ranges must be arranged for one year, and date ranges cannot overlap.
- Click to delete the settings of the corresponding date segment.

3. Click **Purchasing Electricity Price** and set the purchasing electricity price in the same way.

**Step 8** Click **Next**. The **Other Information** tab page is displayed. Set other information about the plant.

Figure 2-7 Other information

The screenshot shows a web form titled "Add New Plant" with a close button (X) in the top right corner. The form has five tabs: "Basic Information", "Access Device", "String Configuration", "Electric Price Configuration", and "Other Information" (which is currently selected). The "Other Information" tab contains the following fields and controls:

- Plant image:** A text input field with a green "..." button to its right. Below it is a note: "The image size cannot exceed 5 MB. Supported formats are jpg, png, jpeg, and bmp." A placeholder image of a house and sun is shown in a box, with a green "Upload" button to its right.
- Address:** A text input field with a red asterisk (\*) to its right.
- Start time of safe running:** A date input field containing "26/03/2019" and a calendar icon to its right.
- Plant introduction:** A text input field.
- Plant time zone:** A dropdown menu showing "(UTC-08:00) 太平洋时间(美国和加拿大)".

At the bottom of the form are three green buttons: "Previous", "Save", and "Cancel".

 **NOTE**

The start time of safe running refers to the time when the plant starts to generate energy normally. It is used to calculate the safe running days of the plant.

**Step 9** Click **Save**. A prompt dialog box is displayed.

**Step 10** Click **OK** to return to the home page of multi-plant interface. Click **Cancel** to return to the **Plant Information Configuration** page.

----End

## Modifying or Deleting a Plant

In the plant list, select the plant to be operated, and click **Modify** or **Delete** to modify or delete the plant respectively.

## 2.3 Company Management

This section describes how to create a company structure in a hosting center.

### Context

- By default, the system has one root node, that is, the hosting structure. Under this node, you can create a company structure based on site requirements.
- When adding a company under the root node, you need to add a common user and assign a role to the user as the administrator of the company.


- When a lower-level node is added to any node, roles of the upper-level node are used in the lower-level node.

## Procedure

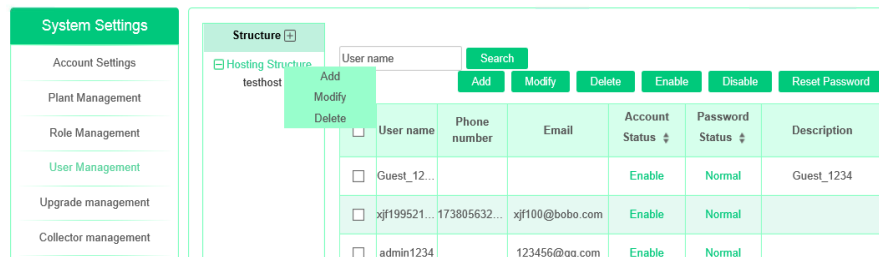
**Step 1** On the home page, click **Setting**. The **System Settings** page is displayed.

**Step 2** In the navigation tree on the left, click **User Management**. The structure and user list are displayed.

**Step 3** Perform the following operations as required.

- Add a company in the hosting center.
  - a. Select **Hosting Structure**. Click  next to **Structure**, or right-click **Structure** and choose **Add** from the shortcut menu. The **Add Structure** dialog box is displayed.

**Figure 2-8** Adding a company



- b. Set basic information about the company.

Figure 2-9 Setting company information

**Add Structure** [X]

**Basic Information** | Role Configuration

Structure name  \*

Structure description

User name  \*

Password  \*

Email  \*

Start date of safe operation

Latitude and longitude  \*

Structure radius  \*

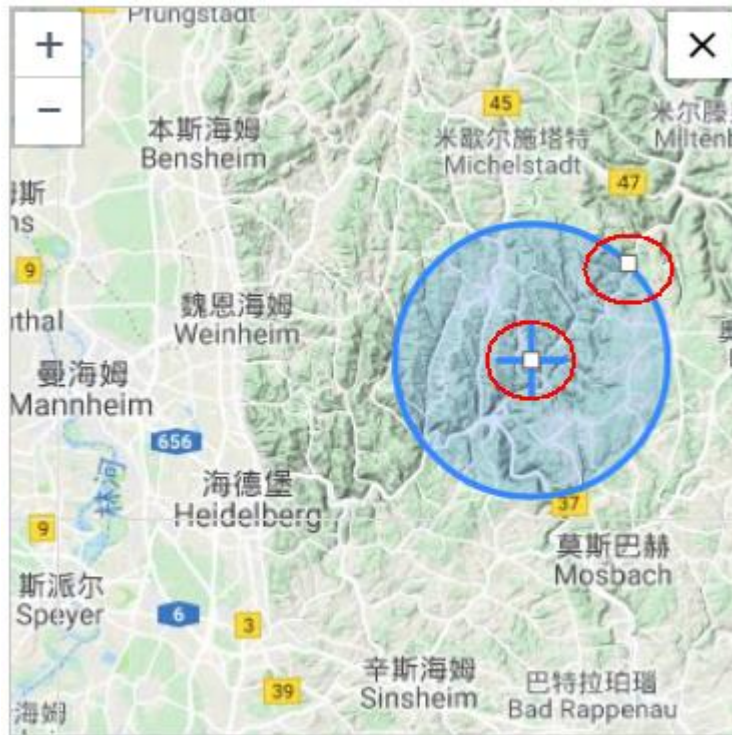
Currency


**Next** **Cancel**

**NOTE**

- The start date for safe running refers to the day when the plant starts to generate energy normally. It is mainly used to calculate the safe running days of the plant.
- The rules for setting a user name and a password are as follows: The user name contains 6 to 32 characters, and the password contains 8 to 32 characters. The user name and password must contain at least two types of the following characters: uppercase letters, lowercase letters, digits, and special characters. The special characters @.-\_ are allowed in the user name, and the special characters `~!@#\$\$%^&\*()-\_+=\|{};:;'"<.>/? are allowed in the password. The user name and password must be different.
- When setting the longitude, latitude, and company radius, you can click the text box next to **Longitude and Latitude**. On the displayed map, drag the circle to set the longitude and latitude, and drag the hollow of the circle to set the radius, as shown in Figure 2-10.

**Figure 2-10** Setting the longitude, latitude, and radius



- c. Click **Next**. The **Role Configuration** tab page is displayed. Set the role name and grant permissions to the role.
- d. Click **Save**. A prompt dialog box is displayed.
- e. Click **OK**. The company is added successfully.
- Add subsidiaries/regions/departments under the company node.
  - a. Select a company name, click  next to **Structure**, or right-click **Structure** and choose **Add** from the shortcut menu. The **Add Structure** dialog box is displayed.
  - b. Set basic company information and click **OK**.



**Figure 2-11** Adding subsidiaries /regions/departments

**Add Structure** ×

Structure name \*

Structure description

Start date of safe operation

Latitude and longitude \*

Structure radius \*

Currency CNY ▼

Supports Poverty Alleviation plant or not

OK Cancel

- c. In the displayed dialog box, click **OK**.
- Modify or delete a company.  
In the navigation tree under **Structure**, right-click the company to be operated and choose **Modify** or **Delete**.

**NOTE**

- **Hosting Structure** cannot be deleted.
- Before deleting a company, delete the users, roles, and subsidiaries of the company. For details about how to delete users and roles, see 2.5 User Management and 2.4 Role Management.

----End

## 2.4 Role Management

This section describes how to add, modify, and delete a role.

### Prerequisites

The company structure has been created. For details, see 2.3 Company Management.

## Context

- A role is a set of permissions that can be assigned to a user. Any operation requires the user to have the corresponding permissions. After login, if the role of a user does not contain a function item or does not have the permission to perform a specific operation, the system does not display the function item or the system displays a message indicating that the user does not have the operation permission.
- After the system is enabled, **Default installer registration role**, **Default Residential plant user role**, and **Default guest role** are preset in the hosting center. The preset roles cannot be deleted. During installer registration, **Default installer registration role** is selected by default.
- If the role to be modified has been assigned to a logged-in user, the user will be logged out. If the role to be deleted has been assigned to a logged-in user, the user will lose the role permissions after logging out of and logging in to the system again.
- For details about the default permission of preset roles, see 1.5 Roles and Permissions.

## Procedure

**Step 1** On the home page, click **Setting**. The **System Settings** page is displayed.

**Step 2** In the navigation tree on the left, click **Role Management**. The role list is displayed.

**Figure 2-12** Managing roles

The screenshot shows the 'System Settings' interface with a left-hand navigation menu. The 'Role Management' option is selected. The main content area displays a table of roles with search and action buttons.

Role Name		Structure	Search	Add	Modify	Delete
<input type="checkbox"/>	Role Name	Structure name	Account Status	Description		
<input type="checkbox"/>	Default installer registration role	Hosting Structure	Enable	Default installer registration role		
<input type="checkbox"/>	Default owner role	Hosting Structure	Enable	Plant home page, device manage...		
<input type="checkbox"/>	Default guest role	Hosting Structure	Enable	Plant home page, device manage...		
<input type="checkbox"/>	Default installer registration role	testhost	Enable	Default installer registration role		
<input type="checkbox"/>	Default owner role	testhost	Enable	Plant home page, device manage...		
<input type="checkbox"/>	Default guest role	testhost	Enable	Plant home page, device manage...		

**Step 3** On the **Role Management** page, you can perform the following operations.

- Add a role.  
Click **Add**, set role information and permission, and click **OK**.

**Figure 2-13** Adding a role

**Add Role** [X]

Role Name [ ] \* Description [ ]

Structure [ ] \* Account Status  Enable  Disable

**Role Authorization \***

Default installer role  Default owner role  Customized role

- System settings
- Home page
- Intelligent O&M
- Report management
- Device management
- System notice
- Dashboard display
- App
- Home page of single plant

[OK] [Cancel]

- Modify or delete a role.  
Select the role to be operated and click **Modify** or **Delete** to modify or delete the role as prompted.

----End

## 2.5 User Management

This section describes how to add, modify, delete, enable, and disable a user.

### Context

- The agent general can register their accounts through the installer registration function on the login page. After the system login, the agent general can create accounts for dealers through the **User Management** page. The account of the Residential plant user is created by the installer.
- The user can be a Residential plant user, guest user, or common user. The user type cannot be changed once it is set.
- If **Password Status** of a user is **Expired**, it indicates that the validity period of the password expires. To ensure system security, change the password immediately. If the password is not changed within the maximum validity period (the initial value is 90

days), the system will forcibly instruct you to change the password before a successful login.

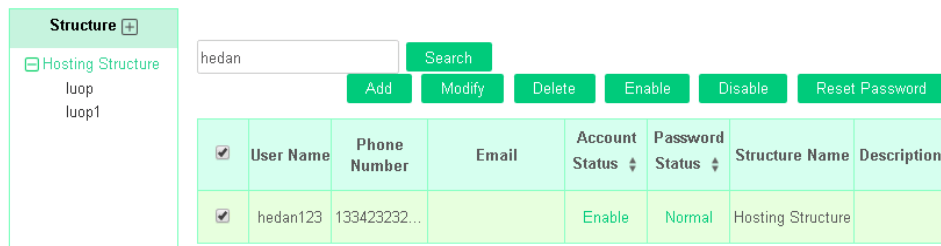
- If you need to log in to the Smart PV Management System through an app, select the related permission on the app during role authorization.

## Procedure

**Step 1** On the home page, click **Setting**. The **System Settings** page is displayed.

**Step 2** In the navigation tree on the left, click **User Management**. The user list of the hosting center is displayed.

**Figure 2-14** Managing users



**Step 3** On the **User Management** page, you can perform the following operations.

- Add a user.  
Select the company to which the new user belongs, click **Add**, and set information about the new user. Then, click **OK**.

**Figure 2-15** Adding a user

Add User
✕

User name
 \*
 Password
 \*

Phone number

Description

Email
 \*

Owner user

**Role\***   **Plant\***

	Role Name	Description	Account Status
<input type="radio"/>	Default installer registration role	Default installer registration role	Enable
<input type="radio"/>	Default owner role	Plant home page, device management,...	Enable
<input type="radio"/>	Default guest role	Plant home page, device management	Enable

⏪ ⏩ 1 ⏪ ⏩
Page 1 Page/Total 1 Page
Go to page  Page
GO

Avatar

Browse
Cancel

Image size cannot exceed 512 KB and the formats supported are: jpg, png, jpeg and bmp.

OK
Cancel

**NOTE**

- The rules for setting the user name and password are as follows:
  - The user name contains 6 to 32 characters, including case insensitive letters, digits, and special characters (@, ., -, and \_).
  - 1. The password contains at least 8 to 32 characters, including at least two types of the following characters: uppercase letters, lowercase letters, digits, and special characters.
  - 2. The user name and password must be different, and the password cannot be the reverse of the user name.
- When adding a user of the **Residential plant user** type, set the user's role to **Default Residential plant user role**. When adding a user of the **Guest user** type, set the user's role to **Default Residential plant user role**. Select a common user based on site requirements.
- Modify or delete a user.
 

Select the target user and click **Modify** or **Delete** to modify or delete the user as prompted.
- Enable or disable a user.
 

Select the target user and click **Enable** or **Disable** to change the user status.

**NOTE**

- The disabled user cannot log in to the system.

- Users cannot disable themselves.
- Users of an upper-level company cannot be enabled or disabled.
- Reset a user password.  
Select the user whose password needs to be reset, click **Reset Password**. Specify **New password** and **Confirm password** to reset the user password.



**NOTE**

Users cannot reset their own passwords or the passwords of users of the upper-level company.

----End

## 2.6 Upgrade Management

This section describes how to upgrade the device.

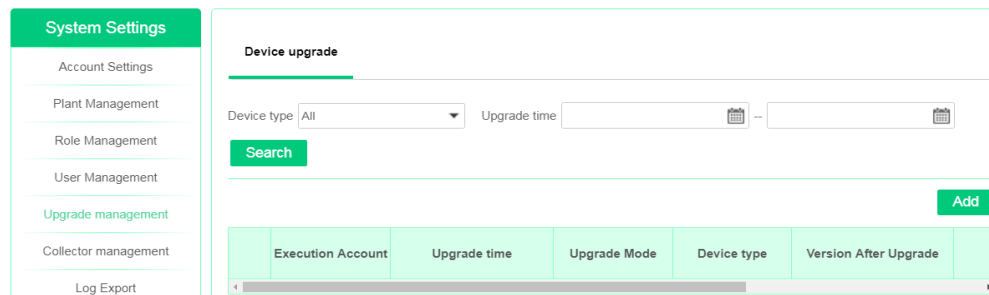
### Context

The following devices can be upgraded: SmartLogger, Pinnet SmartLogger, String Inverter, Smart Energy Center, Smart Dongle, Safety Box, and Optimizer.

### Procedure

- Step 1** On the home page, click **Setting**. The **System Settings** page is displayed.
- Step 2** In the navigation tree on the left, choose **Upgrade Management**. The **Device Upgrade** page is displayed.

**Figure 2-16** Upgrading a device



- Step 3** Click **Add**. The **Add Device Upgrade Task** dialog box is displayed.

**Figure 2-17** Adding a device upgrade task

Add Device Upgrade Task <span>✕</span>	
Upgrade Mode	<input checked="" type="radio"/> Upgrade now <input type="radio"/> User upgrade
Device type	<input type="text"/>
Target version	<input type="text"/>
Device selection	<div style="border: 1px solid #ccc; height: 200px; width: 100%;"></div> <span style="float: right;">Selected 0 device(s)</span>
<input type="button" value="Confirm"/> <input type="button" value="Cancel"/>	

**Step 4** Select the upgrade mode, device type, target version, and devices. Then, click **OK**.

**NOTE**

- **Upgrade now:** You do not need to confirm whether to upgrade the device. After a device upgrade task is added successfully, the task is executed immediately.
- **User upgrade:** After upgrade tasks are added successfully, the system pushes all upgrade messages to all Residential plant users. After a Residential plant user logs in to the system through an app, the user can confirm the upgrade messages one by one. Once a Residential plant user confirms an upgrade message, the corresponding device can be upgraded. If the user does not confirm the device upgrade message over 48 hours, the upgrade result of the device is marked as timeout.

**Step 5** In the displayed dialog box, click **OK**.

In the upgrade task list, click to view the upgrade details.

----End

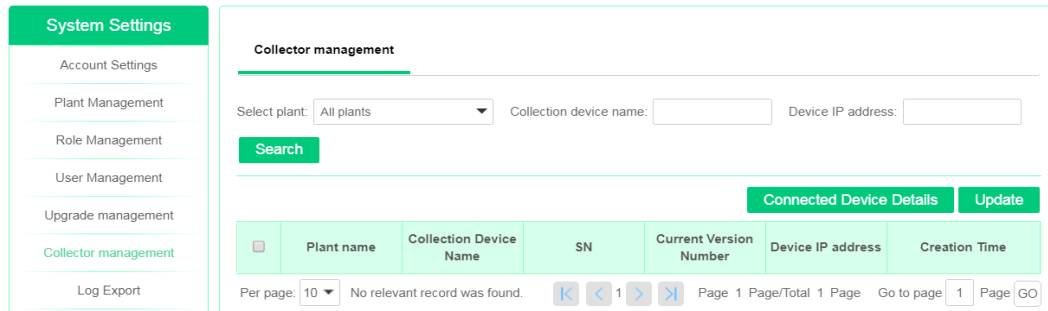
## 2.7 Collector Management

This section describes how to view and manage the devices connected to the Smart Dongle and SmartLogger 1000A.

## Procedure

- Step 1** On the home page, click **Setting**. The **System Settings** page is displayed.
- Step 2** In the navigation tree on the left, choose **Collector Management**. The **Collector Management** page is displayed.

**Figure 2-18** Managing collectors



- Step 3** (Optional) Set query criteria and click **Search**. The collection devices that meet the query criteria are displayed.
- Step 4** Select a collector and click **Connected Device Details** to view details about the devices connected to the collector.



### NOTE

If the device information is updated, click **Refresh** to deliver an update command to the collector and connected devices. View details about the connected devices following the information update.

- Step 5** Manage the connected devices.



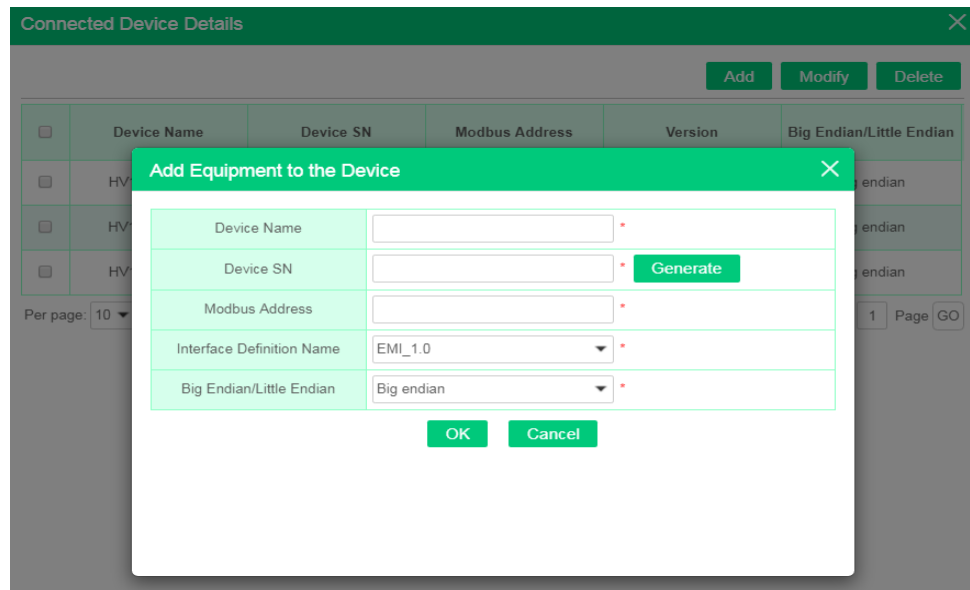
### NOTE

The Smart Dongle supports the addition, modification, and deletion of connected devices. Specifically, the environmental monitoring instrument (EMI) and gateway power meter support only the addition and modification of connected devices. SmartLogger 1000A supports only the deletion of connected devices.

- Add a connected device.  
On the **Connected Device Details** page, click **Add** to add connected devices.



**Figure 2-19** Adding a connected device



- Modify or delete a connected device.  
Select the target device and click **Modify** or **Delete** to modify or delete the device as prompted.

----End

## 2.8 Log Export

This section describes how to export device logs and save the logs to a local PC.

### Context

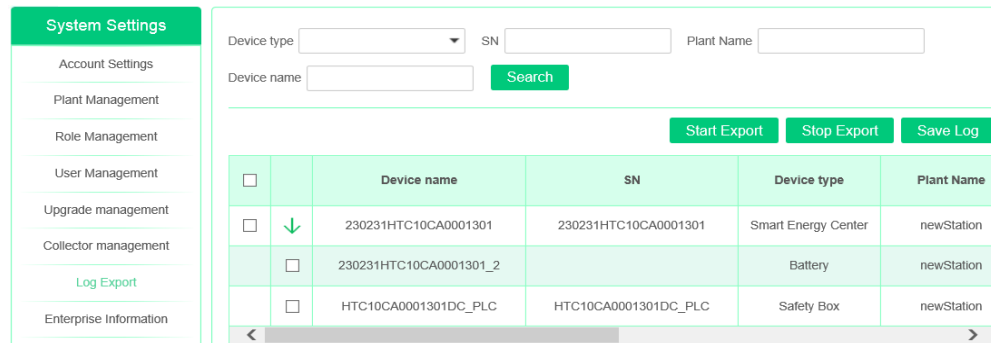
- Logs of the following devices can be exported: SmartLogger, Pinnet SmartLogger, Smart Energy Center, Smart String Inverter, Battery, Optimizer, Safety Box, Smart Dongle, and SmartLogger 1000A.
- Log export, data supplement, and device upgrade cannot be performed at the same time.

### Procedure

**Step 1** On the home page, click **Setting**. The **System Settings** page is displayed.

**Step 2** In the navigation tree on the left, click **Log Export**. The log list of all devices is displayed.

**Figure 2-20** Exporting logs



**Step 3** Perform the following operations as required:

- **Start Export:** In the log list, select one or more devices whose logs need to be exported and click **Start Export** to create an export task.
- **Stop Export:** Select one or more ongoing export tasks and click **Stop Export** to stop the selected tasks.
- **Save Log:** After the logs are exported, select the device whose logs need to be saved and click **Save Log** to download the logs to the local PC.



**NOTE**

- After the logs are exported successfully, the logs will be automatically cleared after 24 hours.
- After the logs are saved successfully, the logs will be automatically cleared after 2 hours.

----End

## 2.9 Enterprise Information Management

This section describes how to set the system logo, title, enterprise information, and mailbox.

### Procedure

**Step 1** On the home page, click **Setting**. The **System Settings** page is displayed.

**Step 2** In the navigation tree on the left, click **Enterprise Information**. The **Logo and Title Configuration** tab page is displayed by default.


- Configure the logo and title.

**Figure 2-21** Configuring the logo and title


<b>Logo and Title Configuration</b>	Enterprise Information Configuration	Enterprise Mailbox Configuration
-------------------------------------	--------------------------------------	----------------------------------

---


Login page title:  [Modify](#)

Login page logo:  Maximum image size is 200 KB. Supported formats: jpg, png, jpeg, or bmp. Recommended pixel is (68 x 68). [Modify](#)

Home page title:  [Modify](#)

Home page logo:  Maximum image size is 200 KB. Supported formats: jpg, png, jpeg, or bmp. Recommended pixel is (33 x 33). [Modify](#)

Dashboard title:  [Modify](#)

Dashboard logo:  Maximum image size is 200 KB. Supported formats: jpg, png, jpeg, or bmp. Recommended pixel is (50 x 50). [Modify](#)

Click **Modify** to configure the title and logo.



**NOTE**

The logo and title parameters on the login page are configurable only for users under the hosting center.

- Configure enterprise information.

**Figure 2-22** Enterprise information configuration

Logo and Title Configuration	<b>Enterprise Information Configuration</b>	Enterprise Mailbox Configuration
------------------------------	---	----------------------------------

---

Enterprise name:  [Modify](#)

Contact details:  [Modify](#)

Enterprise address:  [Modify](#)

Enterprise website:  [Modify](#)

Record number:  [Modify](#)

Click **Modify** to configure the enterprise information.



**NOTE**

Record number is available only to users under the hosting center.

- Configure an enterprise email.

**Figure 2-23** Enterprise email configuration

Logo and Title Configuration   Enterprise Information Configuration   **Enterprise Mailbox Configuration**

---

Email sending server:

User name:

Password:

Port:

Encryption port:

[Modify](#)   [Email server test](#)

Click **Modify** to modify the enterprise mailbox. After setting the email, click **Email server test** to check whether the mailbox is available.

**NOTICE**

You are advised to select **Encryption port** when modifying enterprise mailbox. Otherwise, security risks may exist.

----End

## 2.10 Device License Management

This section describes how to view device license information and how to apply for, load, and revoke a device license.

### Prerequisites

Related devices have been connected on the **Plant Management** page. For details, see 2.2 Plant Management.

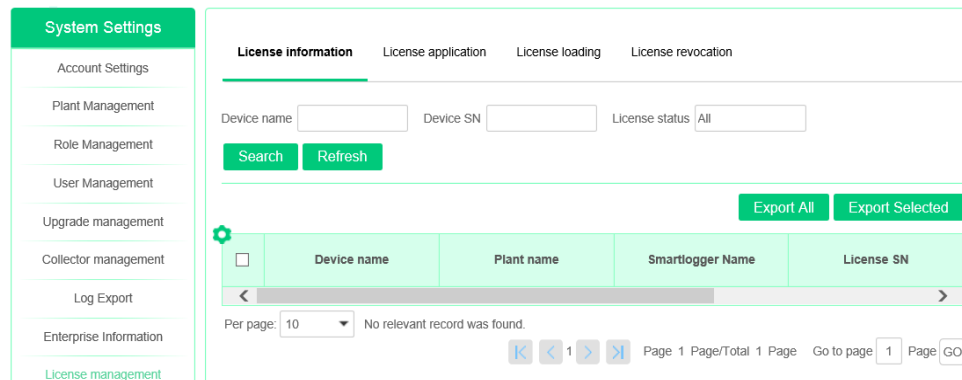
### Context

Before starting the IV curve scanning, you need to load the corresponding device license.

## Procedure

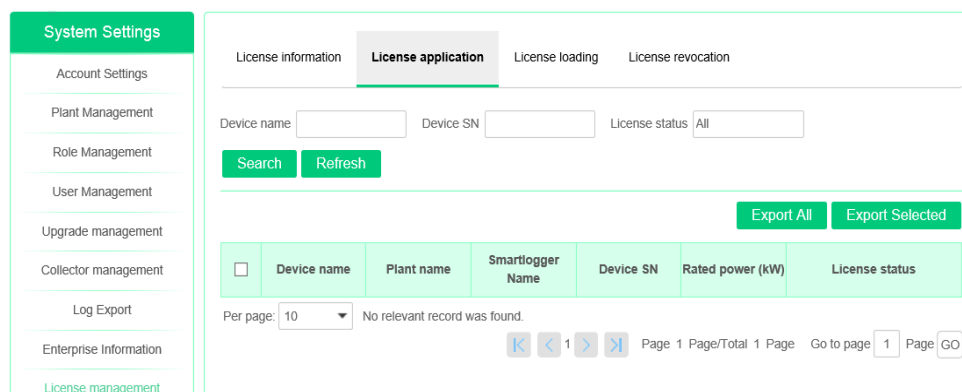
- Step 1** On the home page, click **Setting**. The **System Settings** page is displayed.
- Step 2** Choose **License Management > Device License Management** from the navigation tree on the left. Perform the following operations:
- View license information

**Figure 2-24** License information



- Click **Refresh** to load the latest license information.
- **Export All** indicates that all items in the list are exported. You need to select the items to be exported before selecting **Export Selected**.
- Click the setting icon in the upper left corner of the list head to set the columns to be displayed in the list.
- Apply for a license.

**Figure 2-25** License application



- Click **Refresh** to load the latest license information.
- **Export All** indicates that all items in the list are exported. You need to select the items to be exported before selecting **Export Selected**.

**NOTE**

The exported license application form must be sent to Huawei to obtain the activation codes of the corresponding devices. The activation codes used are for device license loading.

- Load a license.

**Figure 2-26** License upload

- Click **Upload License** to upload a license file.



**NOTE**

- The file name cannot exceed 200 characters.
  - The file name or directory name cannot contain ".../", "...\", or "...". Otherwise, the file is regarded as a malicious file and cannot be uploaded.
- After the license file is uploaded successfully, click **Load All** to load licenses for all devices. Alternatively, select the licenses to be loaded and click **Load Selected** to load the license for the selected devices.

During the loading, click **Stop Loading** to stop all the tasks that are being loaded. If you select the loading tasks to be stopped and then click **Stop Loading**, the selected tasks will be stopped.

- Revoke a license.

**Figure 2-27** License revocation

- Click the setting icon in the upper left corner of the list head to set the columns to be displayed in the list.
- Select the devices whose licenses need to be revoked and click **License Revocation**. Revoke related device licenses as prompted.

- For devices whose licenses have been revoked, click **Export All Invalid Codes** or **Export Selected Invalid Codes** to export the license revocation codes of all or selected devices.

----End

# 3 System Public Notices

This chapter describes how to send and receive system public notices.

## 3.1 Viewing Public Notices

This section describes how to view public notices.

## 3.2 Sending Public Notices

This section describes how to send and delete public notices.

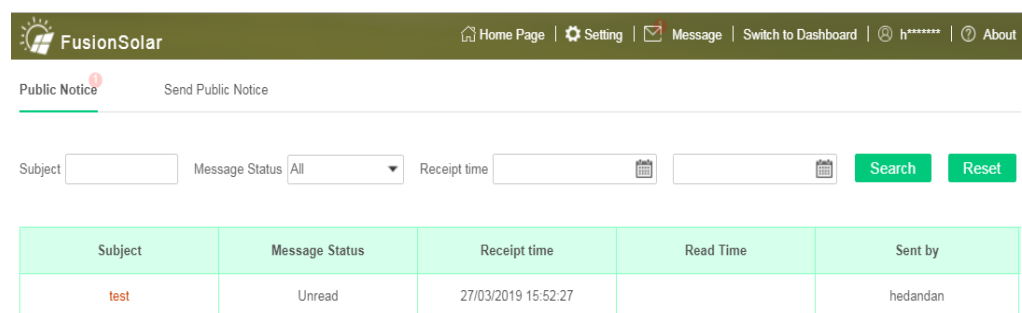
## 3.1 Viewing Public Notices

This section describes how to view public notices.

### Procedure

**Step 1** In the personal center area, click **Message**. The **Public Notice** tab page is displayed.

**Figure 3-1** Public notice



The number of unread messages is displayed on the message box and **Public Notice** tab of the personal center.

**Step 2** Click the subject name of the unread message. The **Message** dialog box is displayed. View the details of the message.

----End



## 3.2 Sending Public Notices

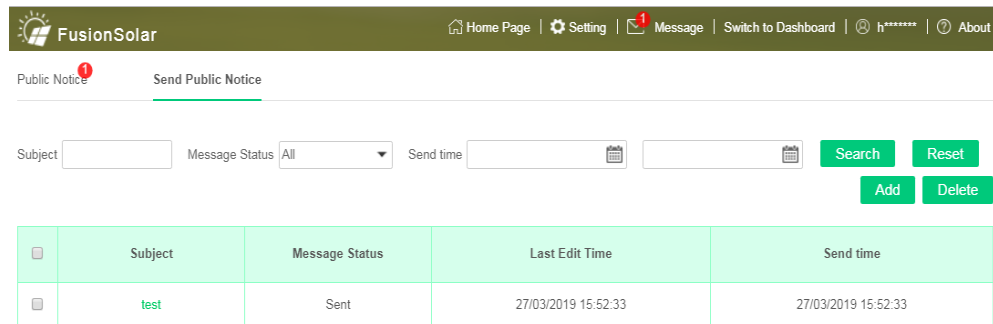
This section describes how to send and delete public notices.

### Procedure

**Step 1** In the personal center area, click **Message**. The **Public Notice** tab page is displayed.

**Step 2** Click the **Send Public Notice** tab. The notices created by the current user are displayed.

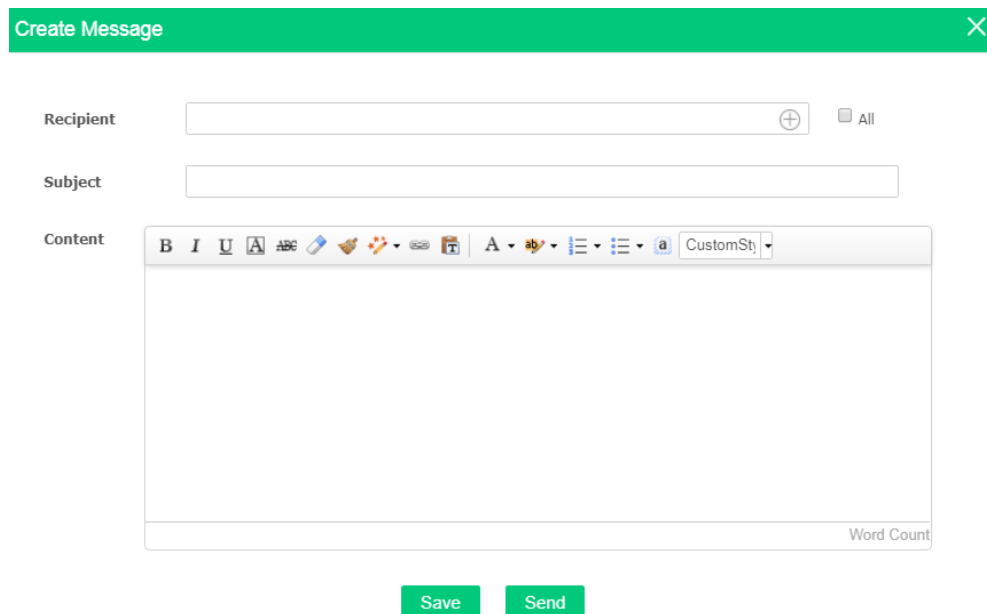
**Figure 3-2** Sending a public notice



Click a notice subject to view the details of the notice.

**Step 3** Click **Add**. The **Create Message** dialog box is displayed.

**Figure 3-3** Creating a message



**Step 4** Select receivers or select **All** and enter the subject and content.

**Step 5** Perform the following operations as required.

- Click **Send** to send the public notice. The notice status is **Sent**.
- Click **Save** to save but do not send the current notice. The notice status is **Draft**.



**NOTE**

For a public notice in **Draft** status, you can click the notice subject to edit, save, or send the notice again.

----**End**

## Follow-up Procedure

Delete a public notice. Select one or more notices to be deleted from the notice list and click **Delete**. You can delete the selected notices.



**NOTE**

The deleted notices are not displayed in the list of the receiver.

---

# 4 Plant Layout

---

This chapter describes how to draw a plant layout and associate it with real devices to implement remote monitoring and management of plant devices.



**NOTE**

Non-Residential plants do not support the plant layout function.

## 4.1 [Creating a Physical Layout](#)

This section describes how to create a physical layout and associate it with devices.

## 4.2 [Viewing the Plant Layout](#)

If a plant layout has been created, you can view the layout in the system.

## 4.1 Creating a Physical Layout

This section describes how to create a physical layout and associate it with devices.

### Procedure

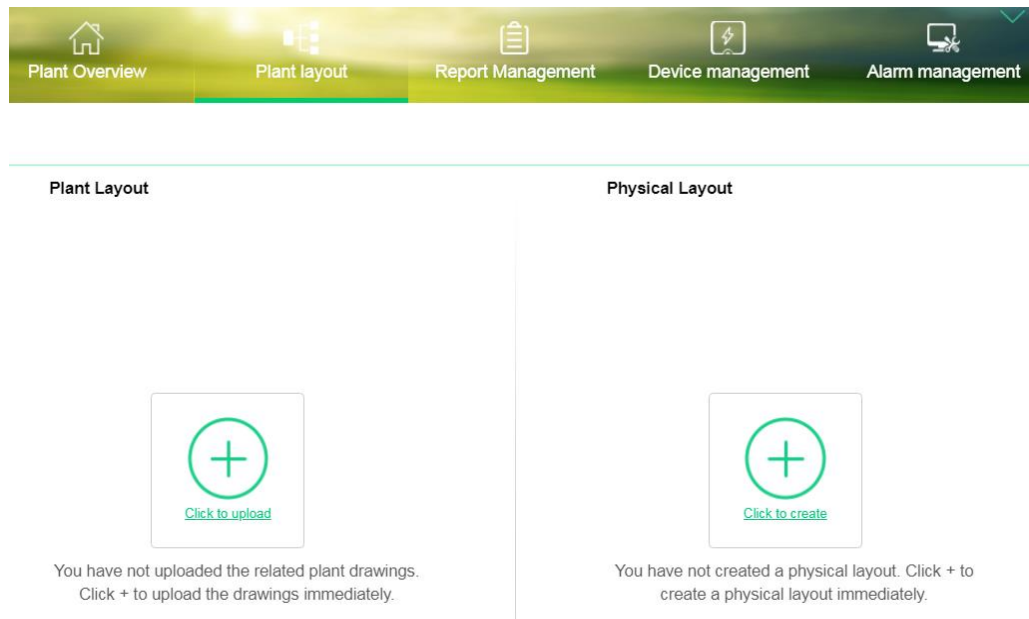
- Step 1** On the plant page, click **Plant Layout**. The page for creating a plant layout is displayed, as shown in Figure 4-1.



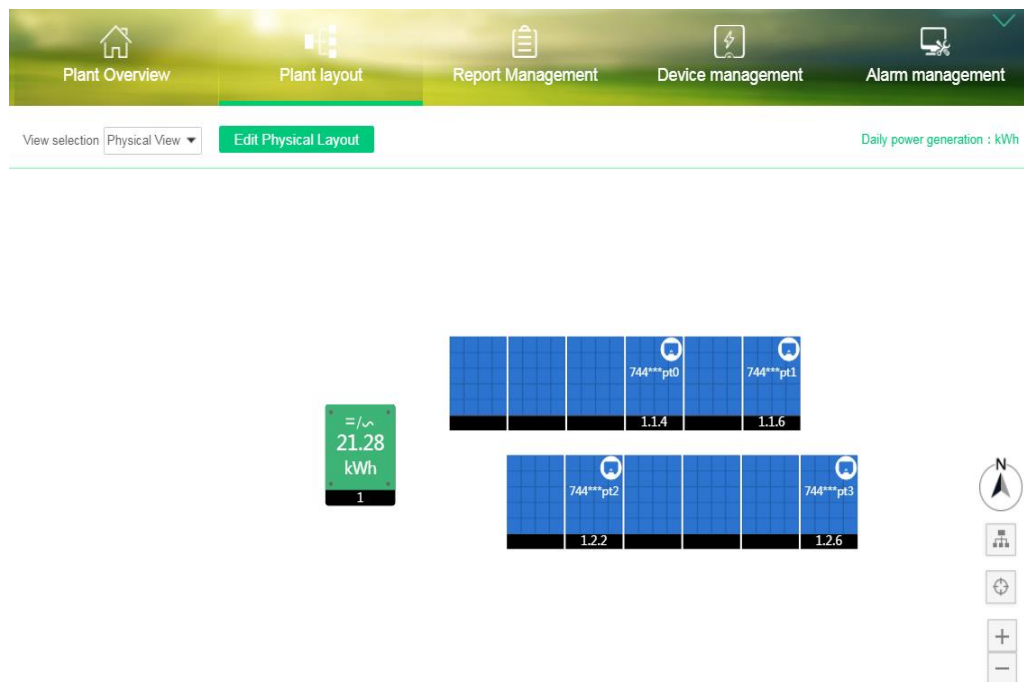
**NOTE**

Only one layout can be created for a plant. If a layout has been created for the plant, the physical layout of the plant is displayed by default, as shown in Figure 4-2.

**Figure 4-1** Creating a layout

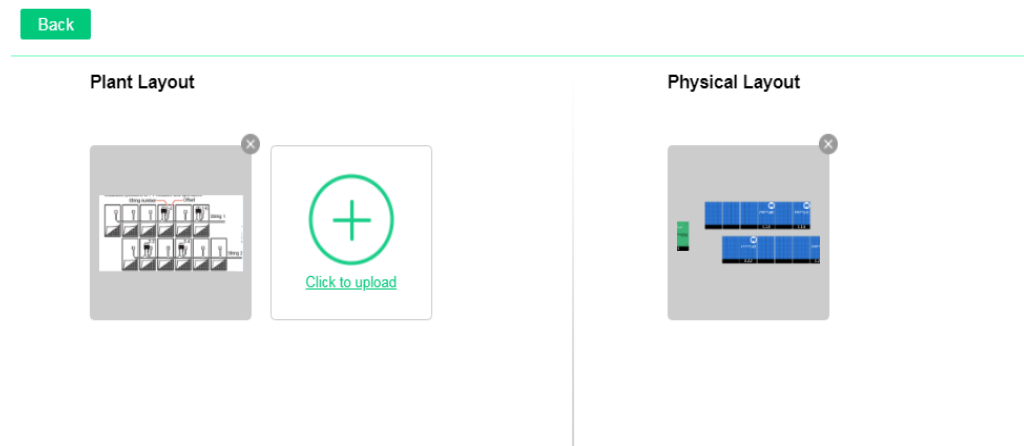


**Figure 4-2** Physical layout



On the physical layout, click **Edit Physical Layout**. The page shown in Figure 4-3 is displayed. Click the thumbnail to modify the layout. You can click the close icon in the upper right corner of the thumbnail to delete the layout.

**Figure 4-3** Editing a layout




**Step 2** (Optional) Click  in the **Plant Layout** area to upload the plant project drawing as the reference for layout.



**NOTE**



- Images in PNG, JPG, JPEG, and BMP formats can be uploaded. The image size cannot exceed 5 MB.
- Click the drawing thumbnail. The drawing can be zoomed in.
- Click the close icon in the upper right corner of the drawing thumbnail to delete the drawing.

**Step 3** Click  in the **Physical Layout** area or click the existing view thumbnail. The **Physical View Configuration** page is displayed, as shown in Figure 4-4.

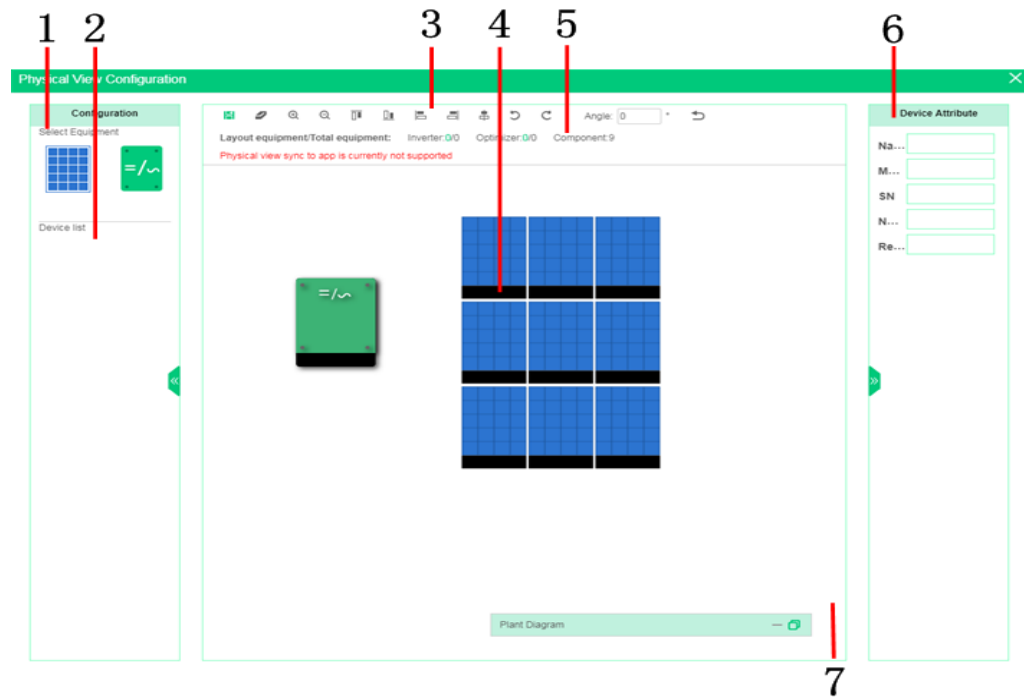
**Step 4** Draw a layout based on site requirements.



**NOTE**

If you need to refer to the project drawing when drawing a layout, click  on the lower right corner of the **Plant Layout** tab page to restore the view. If no drawing display is required, click  to minimize the view.

**Figure 4-4** Physical layout configuration



**Table 4-1** Description about function areas

No.	Area	Description
1	Physical view area	Provides various diagram elements required for drawing a layout.
2	Device list area	Displays the device structure list of the plant.
3	Toolbar	Provides shortcut operations for diagram elements and views.
4	View area	Draws the main operation area of the view.
5	Device statistics area	Displays the number of devices bound to the current view and the total number of devices in the plant.
6	Device attribute setting area	Displays the editable attributes such as device names.
7	Plant drawing	Displays the project drawing of the plant.

1. In the device diagram element area on the left of the page, drag the diagram element to be created to the view area.

2. Set device layout parameters based on site requirements.  
For example, you need to set the quantity and installation mode of inverter diagram elements. For other devices, set the parameters according to site requirements.
3. Click **Save**. The created device diagram element is displayed in the view area.
4. Click a device diagram element and set device attribute values in the device attribute area.
5. Repeat [Step 4.1](#) through [Step 4.4](#) until diagram elements are created completely.



**NOTE**

In the view area, you can perform the following operations to adjust the layout of diagram elements:

- Click a diagram element to select it. For the components created in batches, you can click any of them to select all components or double-click any of them to select a single component. Press **Ctrl+A** to select all diagram elements. Hold down **Ctrl** and click multiple diagram elements.
  - After selecting a diagram element, you can drag it to adjust its position. Drag the mouse in the blank view area to move the drawing canvas.
  - Right-click a diagram element to copy or delete it. After copying a diagram element, right-click in the view area to paste the diagram element.
6. In the device list area, select a device, drag it to the corresponding diagram element position, and bind the device to the diagram element.



**NOTE**

- The bound devices are displayed in gray.
- Right-click a diagram element that has been bound to unbind the device.

7. After the drawing is complete, click  on the toolbar to save the settings.

----End

## 4.2 Viewing the Plant Layout

If a plant layout has been created, you can view the layout in the system.





### Procedure

- Step 1** On the single-plant page, click **Plant Layout**. The **Plant Layout** page is displayed.
- Step 2** Select a layout type from the **View selection** drop-down list. The corresponding layout is displayed.



**NOTE**

On the **Plant Layout** page, you can perform the following operations:

- Drag the mouse to move the drawing canvas to view more information on the drawing canvas.
- Click  and  to zoom in or zoom out the layout. You can also zoom in or out the layout by scrolling the mouse.
- Click  to display the logical connection structure of devices in different colors.
- Click  to restore the layout.

----End

---

# 5 Device Management

---

This chapter describes how to set device parameters, replace devices, modify device information, delete devices, and manage device alarms and real-time information.

## 5.1 Setting Device Parameters

This section describes how to set device parameters.

## 5.2 Modifying or Deleting a Device

This section describes how to modify device information and delete devices.

## 5.3 Replacing a Device

This section describes how to replace a device.

## 5.4 Exporting Device Information

This section describes how to export basic device information and historical device data in an Excel file.

## 5.5 Viewing Device Details

This section describes how to view real-time device information, device details, alarms, and historical information.

## 5.1 Setting Device Parameters

This section describes how to set device parameters.

### Context

This function is supported only by Smart String Inverter, Smart Energy Center, Battery, On-grid/Off-grid controller, SmartLogger 1000A, and Smart Dongle.

### Procedure

- Step 1** On the home page, click **Device Management**. All devices of the current user are displayed.
- Step 2** (Optional) In the navigation tree on the left, select a plant. All devices of the selected plant are displayed.



**Step 3** (Optional) Set query criteria and click **Search**. The devices that meet the query criteria are displayed.

**Step 4** In the device list, select the device to be configured and choose **Parameter Settings**.

**Figure 5-1** Parameter settings (1)

PV Area

---

Device type:  Device name:  SN:  Interface definition version number:

<input type="checkbox"/>	Device Status	Plant Name	Device Name	Device Type	Software Version	Interface Definition Version Number
<input type="checkbox"/>		test	1201905luop0	SmartLogger	R02C00	DIST_SmartLogger_1.0
<input type="checkbox"/>		test	1201905luop1	Smart String Inverter	V100R001PC666	SUN2000_3.0
<input type="checkbox"/>		test	1201905luop2	Smart String Inverter	V100R001PC666	SUN2000_3.0
<input type="checkbox"/>		test	luop052000000000000001	Smart Energy Center	V00116	SUN2000L_1.0

**Step 5** On the **Parameter Settings** page, set the parameters according to actual situations.

**Figure 5-2** Parameter settings (2)

Parameter Settings ✕

Inverter\_SUN2000-50KTL

**Parameter Configuration**

- Grid Parameter
- Protection Parameter
- Feature Parameter
- Power Adjustment

Grid code:

Automatic startup upon grid recovery:

Update the page if you failed to obtain the grid code.



**NOTE**

- The parameters vary according to the device type or version. Set the parameters according to the parameter names and parameter ranges on the GUI.
- After setting parameters for a type of devices, you need to click **Set** to make the settings take effect.
- After selecting the grid code, click **Restore Defaults** to restore the default values to the parameters that have default values.

- Click **Refresh** to display the parameter values that have been set for the current device.

----End

## Example

Take parameter settings for Battery as an example.

- Step 1** In the device list, select the Battery devices to be configured.
- Step 2** Choose **Setting > Parameter Settings**. The **Parameter Settings** page is displayed.

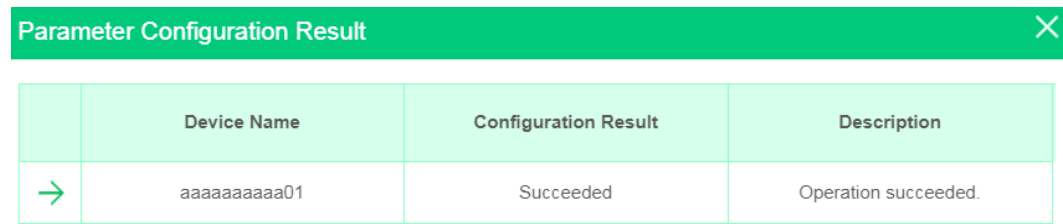
**Figure 5-3** Parameter settings for Battery

Parameter Name	Value	Parameter value range
Communication address	1	[1,247]
Maximum charging power (W)	65537	[0,65537]
Maximum discharging power (W)	65537	[0,65537]
Charging cutoff capacity (%)	0.1	[90,100]
Discharging cutoff capacity (%)	0.1	[12,20]

As shown in Figure 5-3, **Battery Control**, **Control Mode**, **Mandatory Charging and Discharging**, and **Power Grid Charging** are included. You can click a parameter class name to view related parameters that can be set and enter the parameter values.

- Step 3** After setting all parameters, click **Set** at the bottom of the page.
- Step 4** After the settings are complete, the **Parameter Configuration Result** dialog box is displayed.

**Figure 5-4** Parameter setting result



	Device Name	Configuration Result	Description
→	aaaaaaaaa01	Succeeded	Operation succeeded.

**Step 5** Click **OK**.

----End

## 5.2 Modifying or Deleting a Device

This section describes how to modify device information and delete devices.

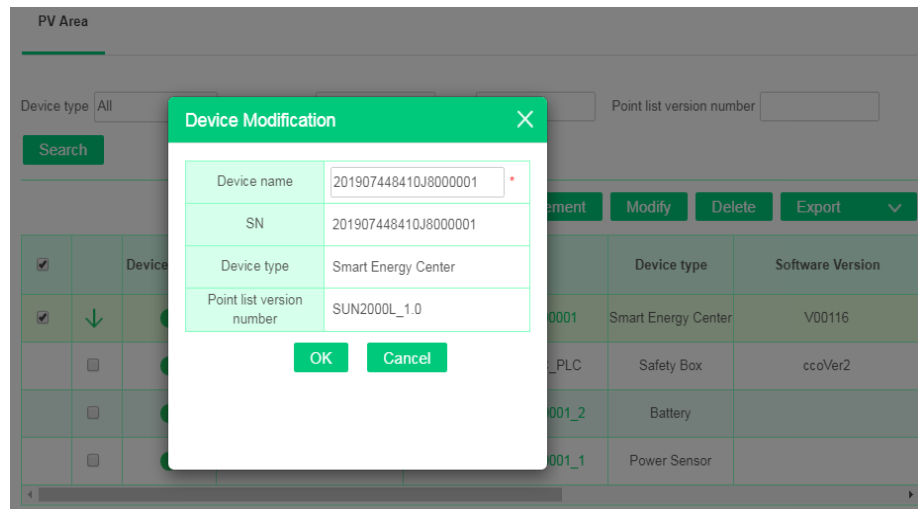
### Context

During the modification of Smart String Inverter and Central Inverter, the associated Transformers can be modified. During the modification of DC Combiner Box, the associated inverter information can be modified.

### Procedure

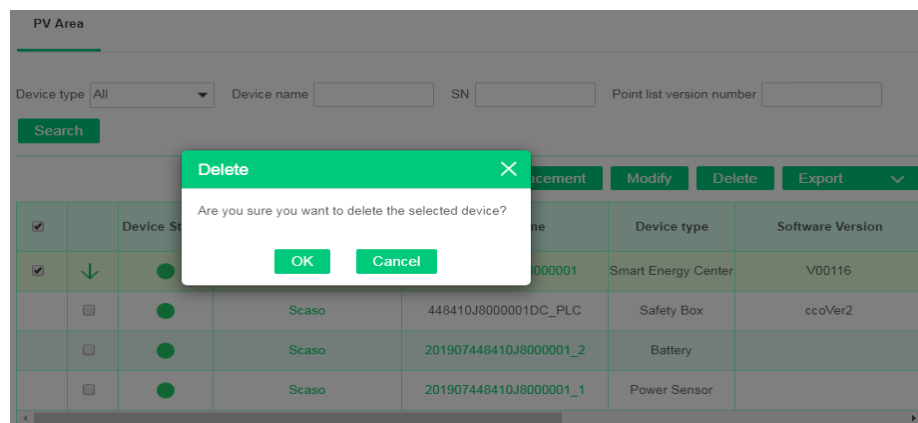
- Step 1** On the home page, click **Device Management**. All devices of the current user are displayed.
- Step 2** (Optional) In the navigation tree on the left, select a plant. All devices of the selected plant are displayed.
- Step 3** (Optional) Set query criteria and click **Search**. The devices that meet the query criteria are displayed.
- Step 4** Modify or delete devices.
  - Modify a device.  
In the device list, select a device and click **Modify** to modify the device information.

**Figure 5-5** Modifying devices



- Delete a device.  
In the device list, select one or more devices and click **Delete** to delete the selected devices.

**Figure 5-6** Deleting devices



----End

## 5.3 Replacing a Device

This section describes how to replace a device.

### Context

Only Smart String Inverters, Smart Energy Centers, and Smart Dongles connected to the SmartLogger can be replaced.

## Procedure

- Step 1** On the home page, click **Device Management**. All devices of the current user are displayed.
- Step 2** (Optional) In the navigation tree on the left, select a plant. All devices of the selected plant are displayed.
- Step 3** (Optional) Set query criteria and click **Search**. The devices that meet the query criteria are displayed.
- Step 4** In the device list, select the device to be replaced and click **Device Replacement**.

**Figure 5-7** Device replacement

The screenshot shows a 'Device Replacement' dialog box. It is split into two columns. The left column, titled 'Current Device', contains the following information: Point list version number: SUN2000L\_1.0, SN: 230231HTC10CA0001301, Software version: V00116, and Inverter type: SUN2000L. The right column, titled 'Target Device', contains an input field labeled 'Enter the target device SN.', a 'Query' button, and a 'Replace' button. A large green arrow points from the 'Current Device' section to the 'Target Device' section.

- Step 5** Enter the SN of the target device and click **Query**. The target version, SN, device version, and model are automatically displayed on the current page.
  - Step 6** Click **Replace** and follow the instructions to replace the current device with the target device.
- End

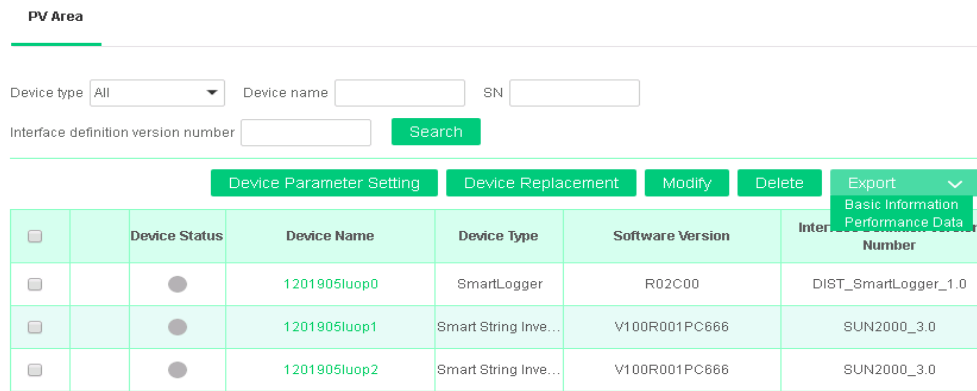
## 5.4 Exporting Device Information

This section describes how to export basic device information and historical device data in an Excel file.

### Procedure

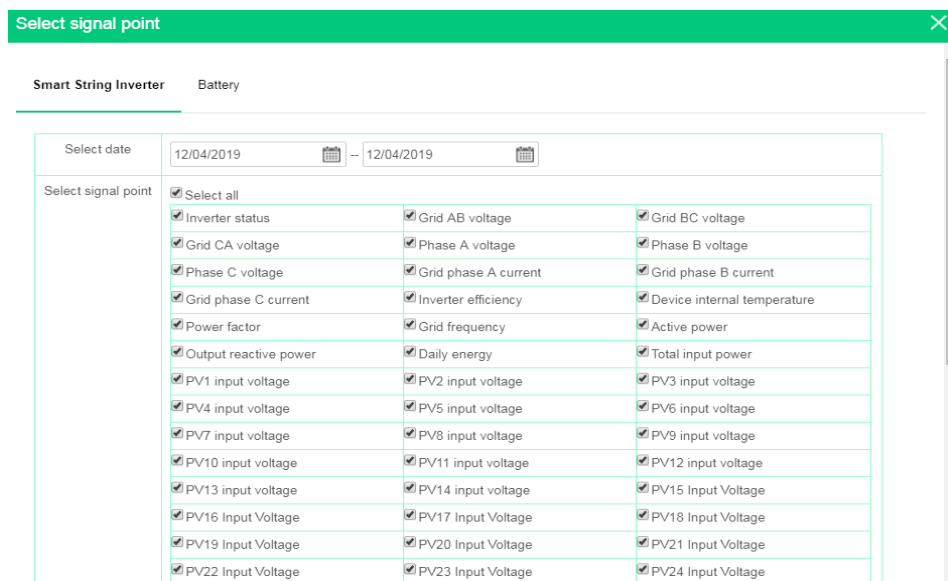
- Step 1** On the home page, click **Device Management**. All devices of the current user are displayed.
- Step 2** (Optional) In the navigation tree on the left, select a plant. All devices of the selected plant are displayed.
- Step 3** (Optional) Set query criteria and click **Search**. The devices that meet the query criteria are displayed.
- Step 4** Select one or more devices and click **Export**.

**Figure 5-8** Exporting data



- Export basic information.  
Choose **Export > Basic Information** to export basic device information, including the plant, device name, device type, software version, interface definition version number, SN, and SIM card number.
- Export performance data.  
Choose **Export > Performance Data** to export the historical data of the selected device. During the export, you can select the time range and signal point to be exported.

**Figure 5-9** Exporting performance data



----End

## 5.5 Viewing Device Details

This section describes how to view real-time device information, device details, alarms, and historical information.

## Procedure

- Step 1** On the home page, click **Device Management**. All devices of the current user are displayed.
- Step 2** (Optional) In the navigation tree on the left, select a plant. All devices of the selected plant are displayed.
- Step 3** (Optional) Set query criteria and click **Search**. The devices that meet the query criteria are displayed.
- Step 4** Click the device name. Then, choose **Device Details > Real-time Information**.



### NOTE

- In the device list, click to view the information of the connected devices.
- Click the plant name. Detailed plant information page is displayed.
- The meanings of the device status are as follows:
- : The device is normal.
- : The device is faulty.
- : The device is disconnected.

**Figure 5-10** Device list

PV Area

---

Device type:  Device name:  SN:

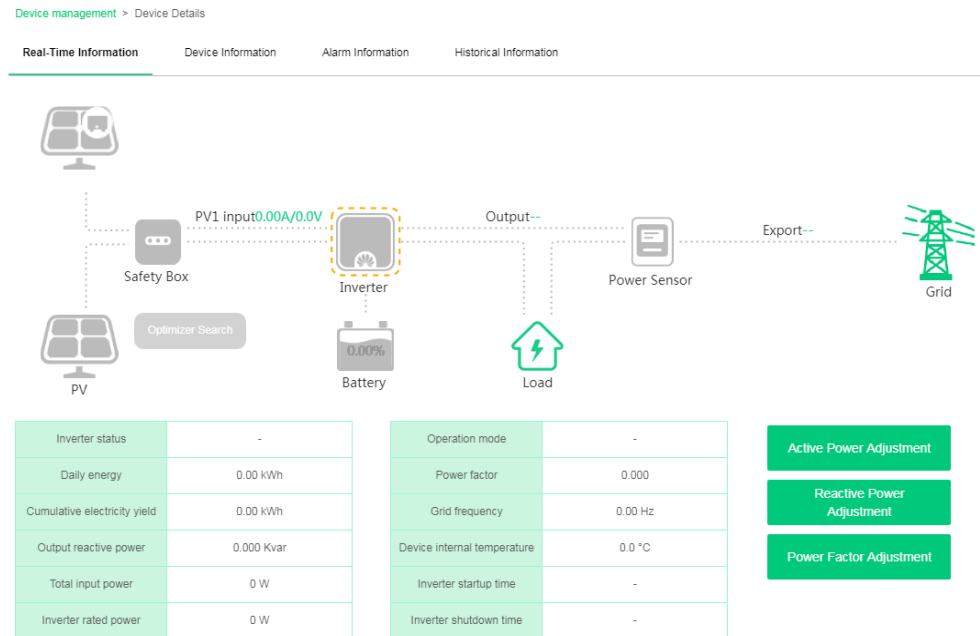
Interface definition version number:

<input type="checkbox"/>		Device Status	Device Name	Device Type	Software Version	Interface Definition Version Number
<input type="checkbox"/>			1201905luop0	SmartLogger	R02C00	DIST_SmartLogger_1.0
<input type="checkbox"/>			1201905luop1	Smart String Inve...	V100R001PC666	SUN2000_3.0
<input type="checkbox"/>			1201905luop2	Smart String Inve...	V100R001PC666	SUN2000_3.0
<input type="checkbox"/>			luop0520000000000001	Smart Energy Ce...	V00116	SUN2000L_1.0
<input type="checkbox"/>	<input type="checkbox"/>		Optimizer(10)	Optimizer	P001V002	SUN2000P_1.0
<input type="checkbox"/>			luop0520000000000001_2	Battery		CN2000_1.0

- Step 5** Click each tab to view device information in different dimensions. The following figure uses Smart Energy Center as an example.

- Real-time message

**Figure 5-11** Real-time message



- If the current device is a host inverter host, click the **Parallel Device** tab to view the associated parallel device list. Click the parallel device name in the list to view details about the parallel device. The operations on the parallel device are the same as those on the host inverter.
- If the current device is a parallel inverter, you can click the host inverter name to view details about the associated host inverter.
- If the inverter is connected to optimizers, click the optimizer diagram elements on the energy flow diagram to view the real-time information about the optimizers. Click **Optimizer Search** to deliver instructions to the inverter to search for and sort the optimizers.
- On the energy flow diagram, click diagram elements of the meter, Battery, and On-grid/Off-grid controller to load the device details.
- Click **Active Power Adjustment**, **Reactive Power Adjustment**, **Power Factor Adjustment** to adjust the active power, reactive power, and power factor respectively.
- Device information



**Figure 5-12** Device information

Device management > Device Details

Real-Time Information   **Device Information**   Alarm Information   Historical Information

Device name	qqq01	Manufacturer name	Huawei	Device type	Smart Energy Center
IP address	10.169.222.124	SN	qqq01	Device replacement record	-
Device address	成都	Model	SUN2000	Software version	V00116
Group information	-				

String Details

String	String 2in1	Component manufacturer	Component Model	Component type	Maximum Power of Component (Wp)	String Component Number (Blocks/String)	String Capacity (kWp)
PV1	<input type="checkbox"/>	Risun Solar	RSM72-156P 300-325W	Polycrystal	300.000	20	6000
* Maximum Power of Component (Wp)		300	* Optimum component operating voltage (Vmp) (V)	31.2	* Optimum component operating current (Imp) (A)	8.36	
* Open-circuit voltage of component (Voc) (V)		45.22	* Short-circuit current of component (Isc) (A)	8.87	* Temperature coefficient of the maximum power (Pmax) (%/°C)	-0.416	
* Temperature coefficient (%/°C) of open-circuit voltage (Voc)		-0.309	* Temperature coefficient (%/°C) of short-circuit current (Isc)	0.049	* Component type	Polycrystal	
* Component manufacturer		Risun Solar	* Number of component batteries per module (pieces/block)	72	* Grid connection date of component	28/03/2019	
* Component attenuation rate in the first year (%/y)		2.5	* Year-on-year component attenuation rate (%/y)	0.7	Component Model	RSM72-156P 300-325W	
Fill Factor (%)		74.85	Standard component conversion ratio (%)	15.5			

- Alarm information

**Figure 5-13** Alarm information

Device management > Device Details

Real-Time Information   Device Information   **Alarm Information**   Historical Information

**Confirm**   **Clear**   **Recovery**

	Plant Name	Device Type	Device Name	Alarm Type	Alarm Name	Alarm ID	Cause ID	Alarm Severity	Status	Local Time	Generation Time	Recovery Time	Recovery Suggestion
<input type="checkbox"/>	东一电站	Smart Energy...	qqq01	Abnor...	Device communic...	65534	1	Major	Activ...	28/03/2019 17:31...	28/03/2019 17:31...		Recovery Su...

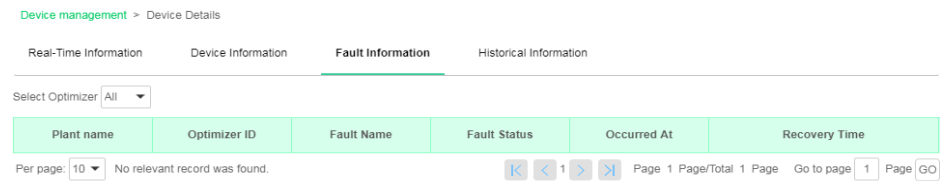
Per page: 10 Total 1 records   Page 1 Page/Total 1 Page Go to page: 1 Page GO

- Click **Recovery Suggestion** corresponding to an alarm to view the alarm cause and handling suggestions.
- Select an alarm to be operated and click **Confirm**, **Clear**, or **Recover** to perform the related operation.

**NOTE**

- The alarm confirmation is irreversible.
- Only alarms in active, confirmed, processed, or processed status can be cleared.
- Only alarm in active or confirmed status can be transferred to fault recovery.
- Fault information (supported only by the optimizer)

**Figure 5-14** Fault information



Select the optimizer to be viewed from the drop-down list of **Select Optimizer**. The fault information about the selected optimizer is displayed.

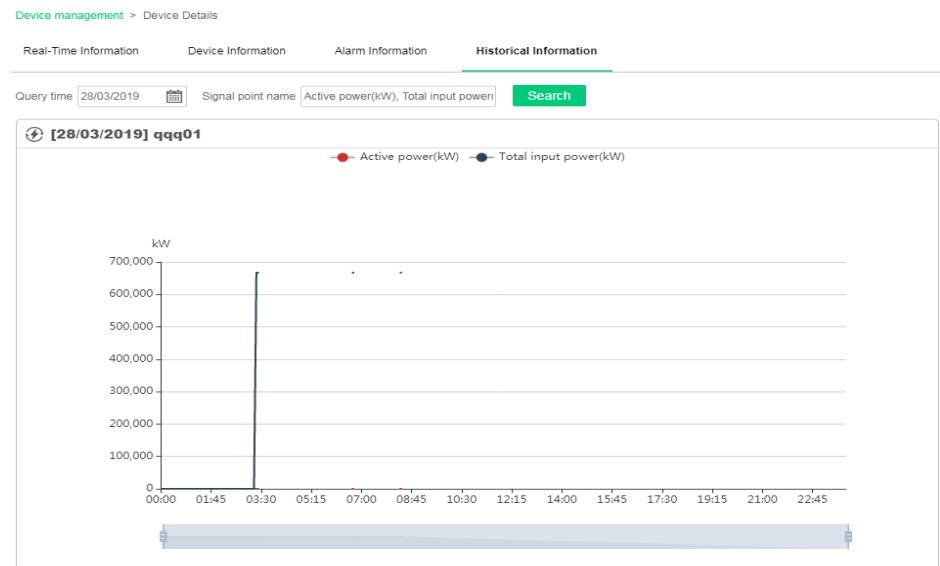
- Historical information



**NOTE**

A maximum of two unit types of signal points are supported, and a maximum of 20 signal points can be selected for each unit.

**Figure 5-15** Historical information



Drag the time axis below the fold-line graph to display only historical data in the specified period.

**----End**

---

# 6 Intelligent O&M

---

This chapter describes how to view the real-time status of a plant, manage device alarms, manage fault recovery, and perform string intelligent diagnosis.

## 6.1 Real-Time Status

This chapter describes how to compare plants, view the plant map and alarms, and assign work orders.

## 6.2 Device Alarm Management

This chapter describes how to view and manage real-time and historical alarms of devices and transfer device alarms to fault recovery.

## 6.3 Fault Recovery Management

This section describes how to add, process, confirm, and view the fault recovery result.

## 6.4 IV Curve

This section describes how to create an IV curve diagnosis task and view the diagnosis result details.

## 6.1 Real-Time Status

This chapter describes how to compare plants, view the plant map and alarms, and assign work orders.

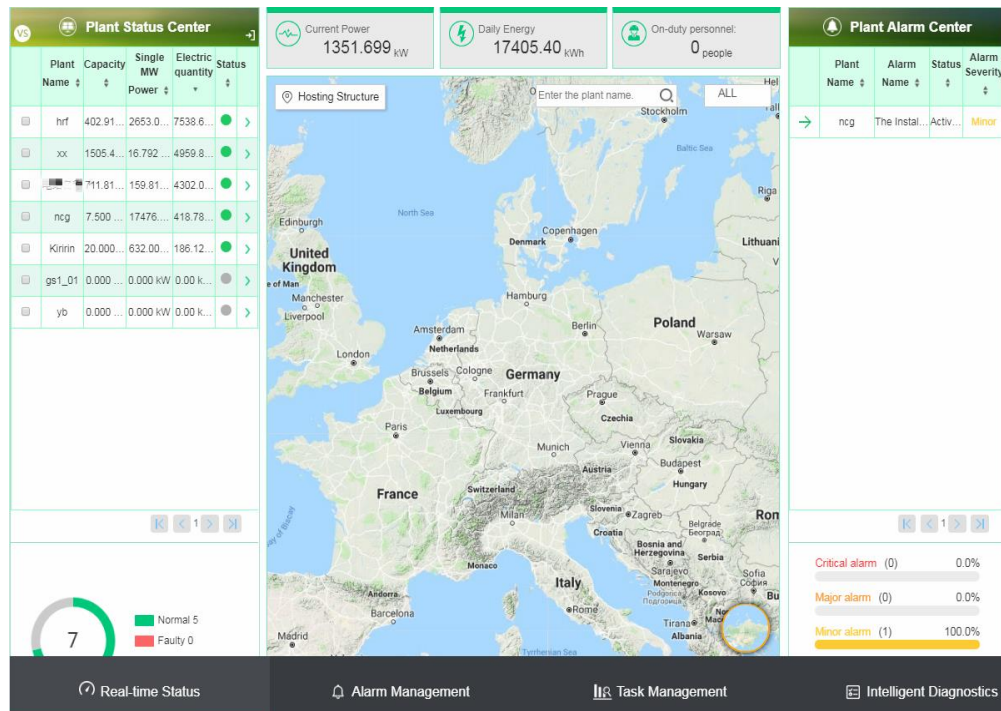
### 6.1.1 Viewing Plant Status

This section describes how to view the plant status, single-MW power comparison diagram, and equivalent usage hour comparison chart.

#### Procedure

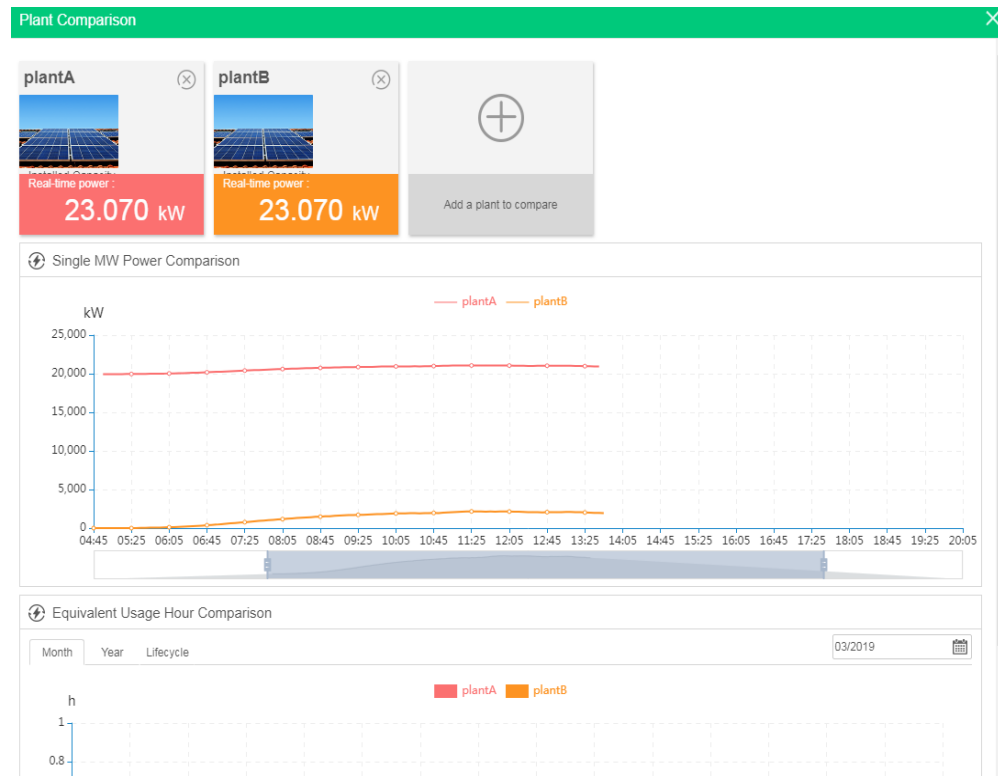
**Step 1** On the home page, click **Intelligent O&M**. The **Real-time Status** page is displayed.

**Figure 6-1** Real-time status






**Step 2** In the **Plant Status Center** area, select the plant to be compared (five at most) and click the comparison icon in the upper left corner of the page. The **Plant Comparison** page is displayed.

**Figure 6-2** Plant comparison



**Step 3** On the **Plant Comparison** page, view the single-MW power comparison chart and equivalent usage hour comparison chart of the selected plant.

- Click  to remove a plant that participates in the comparison.
- Click  to add a plant to be compared.
- Drag  below the comparison chart to display the plant comparison chart in the specific period.

----End

## 6.1.2 Viewing a Plant Map

This section describes how to view a plant map.

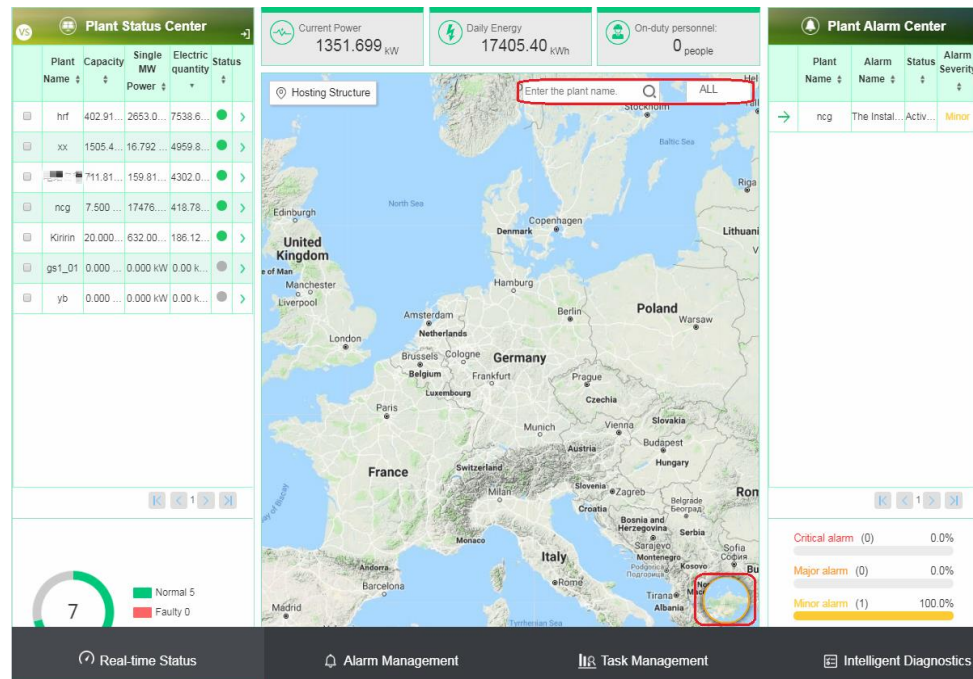
### Context

The plant map displays only the non-Residential plant users who have logged in to the system through the app FusionSolar.

### Procedure

**Step 1** On the home page, click **Intelligent O&M**. The **Real-time Status** page is displayed.

**Figure 6-3 Plant map**



- Click on the right of the plant list. The plant map displays the details of the plant, and the alarm center displays the alarms of the plant.
- Enter the plant name to search for the plant, or click **All** to select the plant status. The plant that meets the query criteria is displayed on the map.
- Click the mode switch icon in the lower right corner of the map to switch between the satellite map and the 2D map.

----End

### 6.1.3 Viewing Real-Time Alarms of a Plant

This section describes how to manage plant alarms.

#### Context

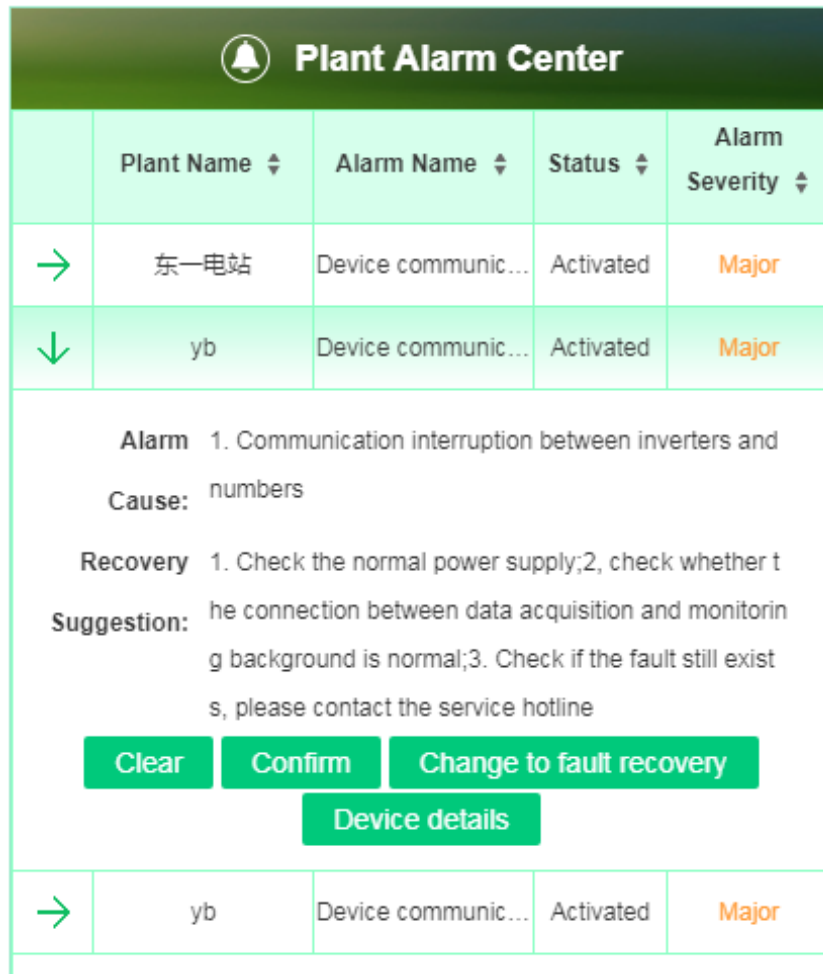
Alarms can be transferred to fault recovery after node handling personnel has been configured. For details about how to set node personnel, see 6.3 Fault Recovery Management.

#### Procedure

**Step 1** On the home page, click **Intelligent O&M**. The **Real-time Status** page is displayed.

**Step 2** On the **Plant Alarm Center** page, active and confirmed alarms are displayed. Click to expand the alarm causes and handling suggestions.

**Figure 6-4** Plant alarm



**Step 3** Perform the following operations as required:

- Click **Clear**. The alarm is cleared from the list.
- Click **OK**. The alarm status changes to **Confirmed**.
- Click **Recovery**. The **New Fault Recovery** page is displayed. You can submit the fault recovery flow. The handling personnel will receive the task.

For details about how to handle a fault recovery task, see 6.3 Fault Recovery Management.

**NOTE**

For an alarm that can be transferred to fault recovery, you can drag the alarm information to the mark point of the O&M personnel displayed on the map to assign a work order to the personnel.

- Click **Device Details** to view device details. For details, see 5.5 Viewing Device Details.
- Drag the alarm information of the plant to the mark point of the O&M personnel displayed on the map to assign a work order to the personnel.

----End

## 6.2 Device Alarm Management

This chapter describes how to view and manage real-time and historical alarms of devices and transfer device alarms to fault recovery.

### Procedure

- Step 1** On the home page, click **Intelligent O&M**.
- Step 2** Click **Alarm Management** in the lower part of the page. The **Device Alarm** page is displayed.

**Figure 6-5** Device alarm

	Plant Name	Device Type	Device Name	Alarm Type	Alarm Name	Alarm ID	Cause ID	Alarm Severity	Status	Local Time	Generation Time	Recovery Time	Recovery Suggestion
		SmartLogger	2Z2GG2019040	Abnor...	Device communic...	65534	1	Major	Reco...	24/04/2019 15:10...	24/04/2019 15:10...	24/04/2019 15:...	Recovery ...
	hrf	Smart Strin...	1zsf123456X2	Abnor...	DC arc fault ( AD...	2002	1	Major	Reco...	24/04/2019 06:47...	24/04/2019 06:47...	24/04/2019 06:...	Recovery ...
	hrf	Smart Strin...	1zsf123456X2	Abnor...	String Reverse C...	2011	2	Major	Reco...	24/04/2019 06:47...	24/04/2019 06:47...	24/04/2019 06:...	Recovery ...
	hrf	Smart Strin...	1zsf123456X2	Abnor...	String current bac...	2012	3	Suggestion	Reco...	24/04/2019 06:47...	24/04/2019 06:47...	24/04/2019 06:...	Recovery ...
	hrf	Smart Strin...	1zsf123456X2	Abnor...	Abnormal String ...	2013	4	Suggestion	Reco...	24/04/2019 06:47...	24/04/2019 06:47...	24/04/2019 06:...	Recovery ...

- Step 3** On the **Device Alarm** page, you can perform the following operations:
  - Query alarms. Set query criteria and click **Search**. Set the query criteria and then click **Save** to save the query criteria as a **User-defined filter**. You can click the name of a user-defined filter to quickly query alarms.
  - Export alarm information. Select the alarm and click **Export**. If you do not select any alarm, you can export a maximum of 10,000 alarm records.
  - Handle alarms. Select an alarm and click **Clear**, **Confirm**, or **To Fault Recovery** to handle the alarm.
  - Click **Recovery Suggestion** to view recovery suggestions.
  - Click a plant name to enter the single-plant page.
  - Click a device name to enter the device details page.

----End

## 6.3 Fault Recovery Management

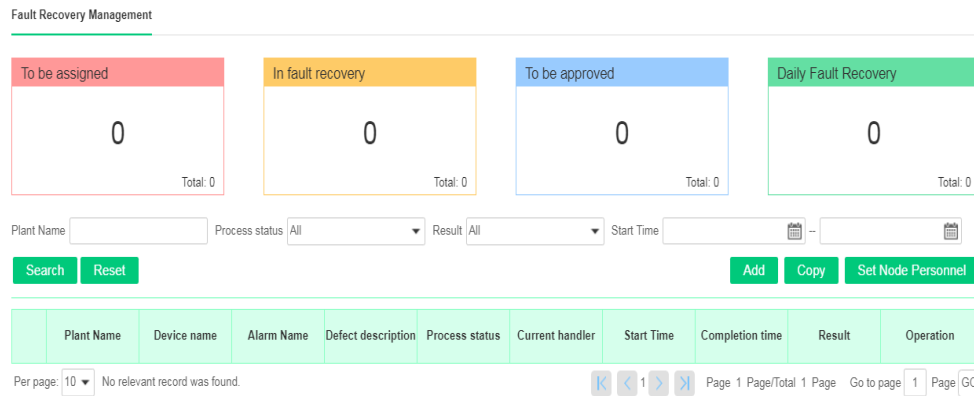
This section describes how to add, process, confirm, and view the fault recovery result.



## Procedure

- Step 1** On the home page, click **Intelligent O&M**.
- Step 2** Click **Task Management** in the lower part of the page. The **Fault Recovery Management** page is displayed.

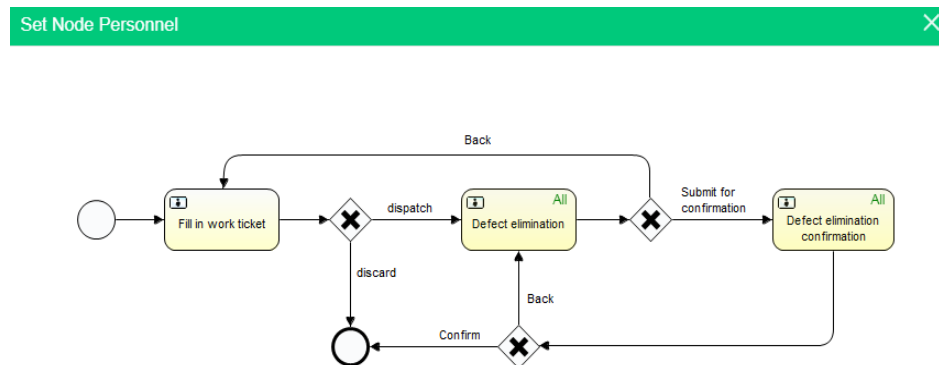
**Figure 6-6** Fault recovery management



**Step 3** On **Fault Recovery Management** page, you can perform the following operations:

- Set node handling personnel.  
Click **Set Node Personnel** and click the flow node to set the processing personnel of the node. If no node personnel is set, all personnel will be selected.

**Figure 6-7** Node personnel settings



- Fill in and dispatch the fault recovery flow through the following methods:
  - Click **Add**.
  - Select an existing fault recovery process and click **Copy**.
  - Click a fault recovery statistics box. The **Fault Recovery Status** page is displayed. Click **Add**.



**NOTE**

The principal owner to be selected must meet the following requirements:

- The user has the permission of fault recovery management.
- The user is in the node personnel list.
- The user is created under the non-hosting center node and has the permissions of the plant to which the device to be recovered belongs.

After fault recovery work order is created, the fault recovery process starts. The main handling personnel starts to execute the next process.

**Figure 6-8** Adding a fault recovery task

New Fault Recovery
✕

Work Order Information

Device name	<input type="text"/>	Plant Name	<input type="text"/>
Device type	<input type="text"/>	Device model	<input type="text"/>
Defect number	<input type="text"/>	Process status	<input type="text"/>
Start Time	<input type="text"/>	Completion time	<input type="text"/>
Current handler	<input type="text"/>	Result	<input type="text"/>

Attachment The file type should be xls, xlsx, doc, docx, zip, rar, jpg, jpeg, png or bmp, and the file size cannot exceed ...

Defect description

Principal owner

Transfer operation  Submit

Handling suggestion

Submit
Cancel

- Perform the fault recovery process (such fault recovery handling and confirmation). In the fault recovery list, click **Execute**. The **Executing Process** page is displayed. Execute the fault recovery process based on the actual fault recovery status.

**Figure 6-9** Execution process

Execution Flow
✕

**Work Order Information**

Device name	1SmartHouse0	Plant Name	Kiririn - 数采户用
Device type	Smartlogger	Device model	Smart Logger
Defect number	201903290001	Process status	In fault recovery
Start Time	29/03/2019 16:06:39	Completion time	
Current handler	jdk123	Result	<span style="border: 1px solid #ccc; padding: 2px;">▼</span>

Attachment The file type should be xls,xlsx, doc, docx, zip, rar, jpg, jpeg, png or bmp, and the file size cannot exceed ...

Defect description 222

Handling suggestion 2

Operator Selection \*

Transfer operation  Submit  Back

Result \*

Submit
Cancel

- View fault recovery information.  
In the fault recovery list, click **Details** to view detailed information. You can view the details, handling process, and flow chart of the fault recovery task.

**Figure 6-10** Fault recovery information

Defect Information
✕

[Defect Details](#)   [Day-to-Day Account](#)   [Flowchart](#)

**Work Order Information**

Device name	1XMX123456X2	Plant Name	峰峰
Device type	Smart String Inverter	Device model	SUN2000-50KTL
Defect number	201904020001	Process status	In fault recovery
Start Time	02/04/2019 11:39:43	Completion time	
Current handler	test123	Result	
Attachment			
Defect description	2222		
Handling suggestion	2222		

----End

## 6.4 IV Curve

This section describes how to create an IV curve diagnosis task and view the diagnosis result details.

### Prerequisites

- The license status of the device to be scanned is normal.
- The inverter connection mode must be Huawei inverters+Huawei SmartLogger+FusionSolar to ensure smooth scanning.
- The Smart Energy Center with an optimizer cannot be scanned.
- Only single-crystal and polycrystalline components can be scanned.

### Context

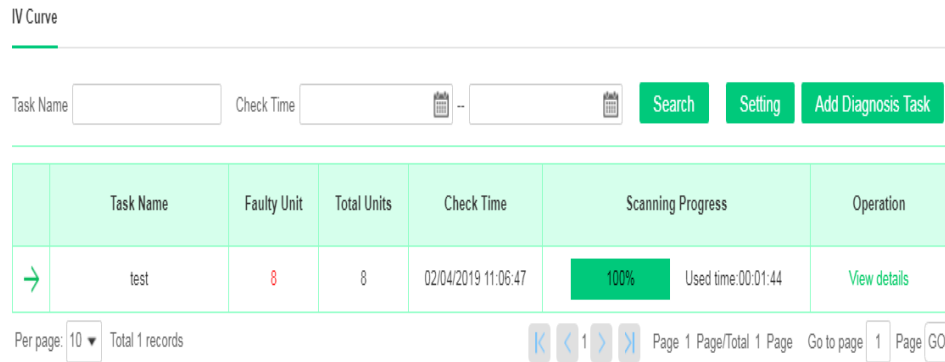
- A maximum of 200 Smart Energy Centers can be used for IV curve diagnosis.
- The Smart Energy Centers in the IV curve diagnosis task cannot participate in other diagnosis tasks.

### Procedure

- Step 1** On the home page, click **Intelligent O&M**. The **Real-time Status** page is displayed by default.

**Step 2** Click the **Intelligent Diagnosis** tab in the lower part of the page. The **IV Curve** page is displayed.

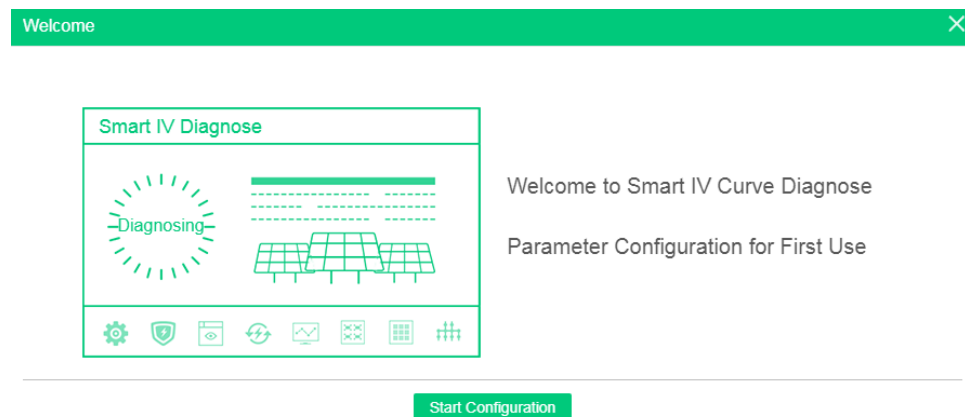
**Figure 6-11** IV curve



**Step 3** (Optional) Configure string details.

If you use the IV diagnosis function for the first time and there are inverters that are not configured with string details, a dialog box is displayed, as shown in Figure 6-12. Click **Setting** to configure related information. You can also click **Parameter Configuration** on the **IV Curve** page to set parameters.

**Figure 6-12** Welcome page



**Step 4** On the **IV Curve** page, perform the following operations:

- Create a diagnosis task. Click **Add Diagnosis Task** to add an IV curve scanning task.

**Figure 6-13** Adding an IV curve scanning task



**NOTE**

- The inverter with an optimizer cannot be scanned. Do not select this type of device.
- **Environment parameter** can be set to **Auto** or **Environment parameter**. If this parameter is set to **Auto**, the system calculates the current radiation intensity and temperature based on the related prediction algorithm. If this parameter is set to **Environment parameter**, specify **Component plane irradiation intensity** and **Component backplane surface temperature**.
- If the radiation intensity does not meet the minimum diagnosis requirement 400W/m<sup>2</sup>, the scanning will not be started.
- View the scanning details. In the task list, click **View details** to view detailed information about the scanned object.

**Figure 6-14** Scanned object details

Number.	Plant Name	Inverter Name	String	Creation Time	End Time	Status
1	Scaso	201907448410J8000001	PV1	02/04/2019 16:36:22	02/04/2019 16:38:30	Succeeded
2	Scaso	201907448410J8000001	PV2	02/04/2019 16:36:22	02/04/2019 16:38:30	Succeeded
3	Scaso	201907448410J8000001	PV3	02/04/2019 16:36:22	02/04/2019 16:38:30	Succeeded
4	Scaso	201907448410J8000001	PV4	02/04/2019 16:36:22	02/04/2019 16:38:30	Succeeded
5	Scaso	201907448410J8000001	PV5	02/04/2019 16:36:22	02/04/2019 16:38:30	Succeeded
6	Scaso	201907448410J8000001	PV6	02/04/2019 16:36:22	02/04/2019 16:38:30	Succeeded
7	Scaso	201907448410J8000001	PV7	02/04/2019 16:36:22	02/04/2019 16:38:30	Succeeded
8	Scaso	201907448410J8000001	PV8	02/04/2019 16:36:22	02/04/2019 16:38:30	Succeeded

- View and export scanning results.
  - Click in the task list to expand **Fault List**.
  - Click **Export** to export the scanning result list. Click **View** in the list to view exception handling suggestions.

**Figure 6-15** Diagnosis task list

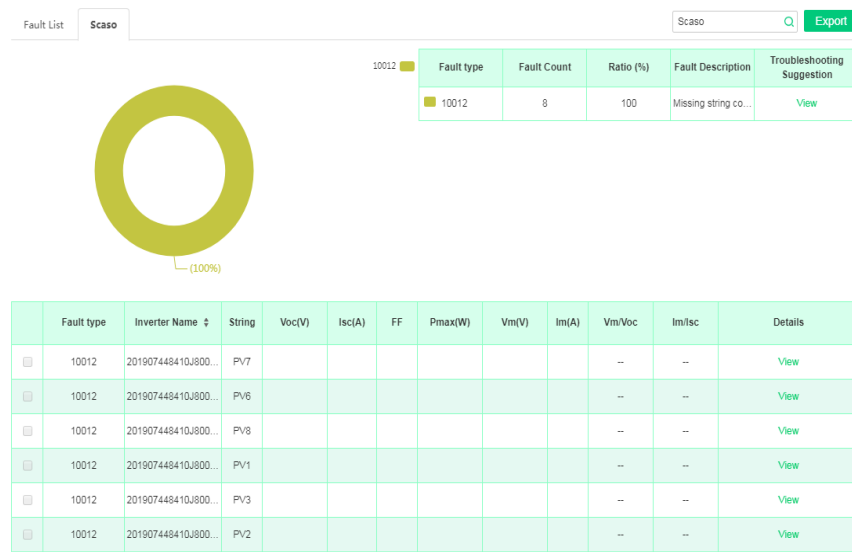
Task Name	Faulty Unit	Total Units	Check Time	Scanning Progress	Operation
test	8	8	02/04/2019 16:36:22	100% Used time:00:02:07	View details

Plant Name	Plant Location	Inverter Name	Inverter SN	String	Fault Description	Handling Suggestion
Scaso	china chengdu	201907448410J8000001	201907448410J8000001	PV1	Missing string configurations	View
Scaso	china chengdu	201907448410J8000001	201907448410J8000001	PV2	Missing string configurations	View
Scaso	china chengdu	201907448410J8000001	201907448410J8000001	PV3	Missing string configurations	View
Scaso	china chengdu	201907448410J8000001	201907448410J8000001	PV4	Missing string configurations	View
Scaso	china chengdu	201907448410J8000001	201907448410J8000001	PV5	Missing string configurations	View
Scaso	china chengdu	201907448410J8000001	201907448410J8000001	PV6	Missing string configurations	View
Scaso	china chengdu	201907448410J8000001	201907448410J8000001	PV7	Missing string configurations	View
Scaso	china chengdu	201907448410J8000001	201907448410J8000001	PV8	Missing string configurations	View

- View and export plant scanning reports.
  - a. Click the name of a plant to be viewed. The detailed report of string scanning is displayed.

**Figure 6-16** Scanning report



- b. View the scanning report and perform the following operations:
  - Click **View** in the fault summary list to view the handling suggestions for the faulty string.
  - Click **View** in the string scanning result list to view the string basic information and IV curve.
  - In the string scanning result list, select the string to be analyzed. In **Comparison analysis of string IV curves**, the fold-line graph corresponding to the string is displayed. Select a maximum of 10 strings for comparison analysis. Click figure description on the comparison figure to cancel the display of the IV curve of the corresponding plant string.

**----End**



# 7 Report Management

---

Report management includes plant report management, inverter report management, and Battery report management.

This section describes how to view, export, and subscribe to reports. The operations about view, exporting, subscribing to reports on the single-plant page are similar to those on the multi-plant page.

## Prerequisites

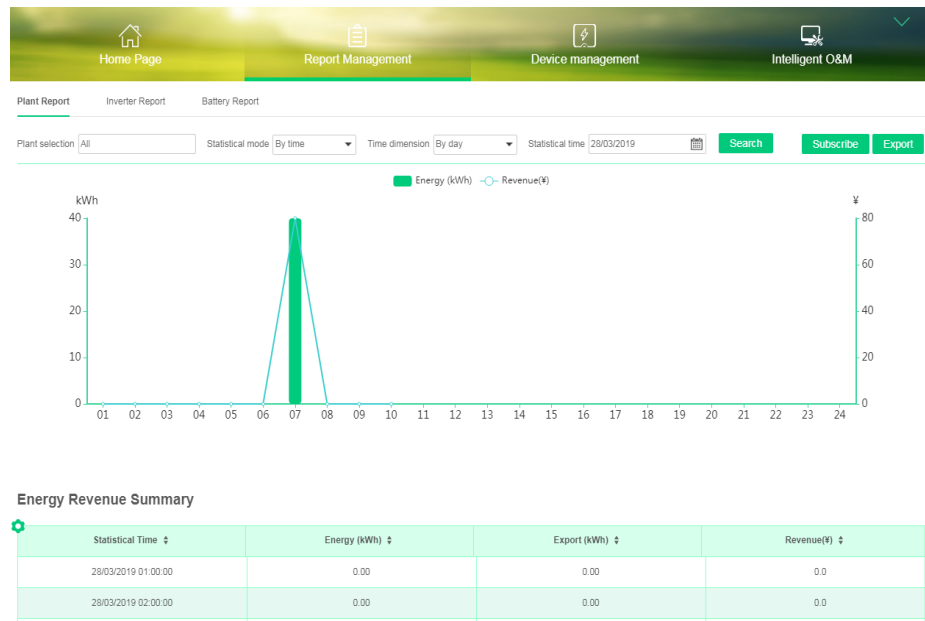
An enterprise email has been configured by choosing **System Settings > Enterprise Information**.

## Procedure

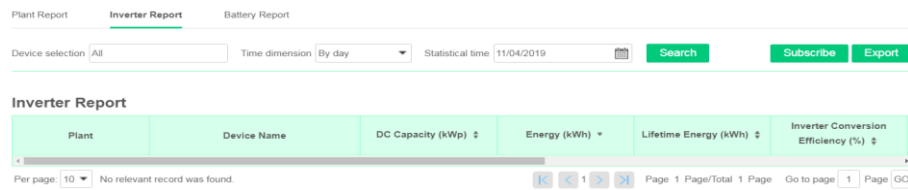
**Step 1** On the home page, click **Report Management**. By default, the **Plant Report** page is displayed. You can click **Inverter Report** or **Battery Report** to view the related report.

- **Plant Report:** Collect the energy and revenues of the plant by time and plants.
- **Inverter Report:** Collect the energy and running status of inverters by year, month, and day.
- **Battery Report:** Collect the charging and discharging batteries by year, month, and day.

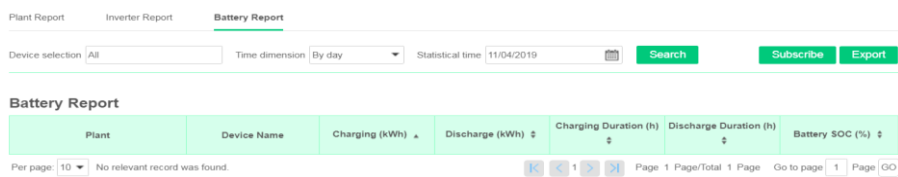
**Figure 7-1** Plant report



**Figure 7-2** Inverter report



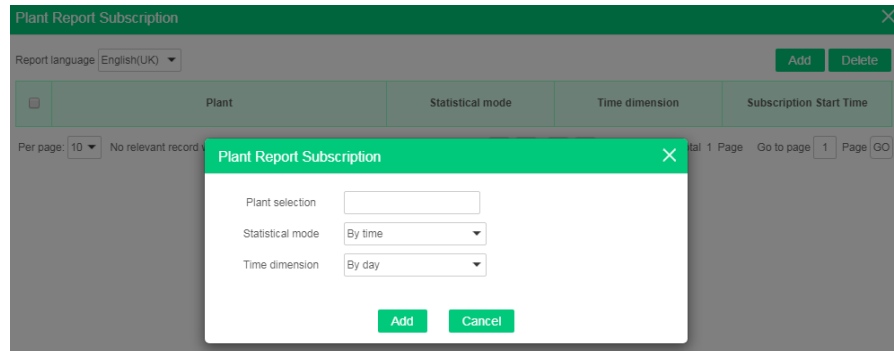
**Figure 7-3** Battery report



**Step 2** Take the plant report as an example. Other reports are similar.

- Query a report. Select the plant and statistical mode, and click **Search** to query the report data.
- Export a report. Click **Export**.
- Subscribe to a report. Click **Subscribe**. On the displayed subscription information configuration page, click **Add**.

**Figure 7-4** Subscribing to reports



**NOTE**

The system sends the statistical report of the previous day to the mailbox of the user at 00:40 (UTC+08:00) on the next day.

**----End**

# 8 FAQs

## 8.1 How Do I Disable the Remote Control Function?

To disable the remote control function of the inverter, modify the `shareconf_web.properties` file as required.

## 8.1 How Do I Disable the Remote Control Function?

To disable the remote control function of the inverter, modify the `shareconf_web.properties` file as required.

### Prerequisites

The FusionSolar version is V300R006C00SPC700 and later.

### Procedure

- Step 1** Go to the `/opt/IEMSHome/IEMS-conf/WebServer-conf/share` directory on the FusionSolar server and open the `shareconf_web.properties` file.

The following information is displayed:

```
#\u5B89\u88C5\u5546\u6CE8\u518C
installer.register=true
#\u662F\u5426\u5141\u8BB8\u77ED\u4FE1\u518C
#\u6B64\u53C2\u6570\u4E5F\u53EF\u7528\u518C
sms.register.enable=false
#\u662F\u5426\u5141\u8BB8\u8FDC\u7A0B\u518C
remote.switchOnOff.enable=false

web.request.url=https://127.0.0.1
```

- Step 2** Change the value of `remote.switchOnOff.enable` to `false` and save the modification.



#### NOTE

`false` and `true` indicate the enabling and disabling of the remote control function, respectively.

- Step 3** Restart the FusionSolar to make settings take effect.

----End